

nextiva



Panasonic KX-UTG 300B

User Guide

Contents

| | |
|---|----|
| Installation | 3 |
| Desk Setup | 3 |
| Installing the Panasonic KX-UTA336 Sidecar | 7 |
| Wall Mounting | 8 |
| Location of Controls..... | 12 |
| Provisioning Instructions | 13 |
| Assigning the Phone to a User using the NextOS 3.0 Beta Portal..... | 13 |
| Checking the Firmware | 18 |
| Entering the Provisioning Server | 21 |
| Enabling the Web Configuration Utility..... | 24 |
| Additional Setup Options..... | 27 |
| Correcting the Time..... | 27 |
| Line Mirroring..... | 27 |
| Busy Lamp Field (BLF) | 27 |
| Directories..... | 27 |
| Speed Dials..... | 27 |
| Automatic Call Distribution (ACD) | 35 |
| Basic Phone Usage..... | 36 |
| Making a Call | 36 |
| Making a Second Call | 37 |
| Accepting a Call..... | 40 |
| Accepting a Second Call..... | 41 |
| Terminating a Call | 42 |
| Transferring a Call | 43 |
| Conferencing | 45 |
| Checking Voicemail..... | 46 |
| Directories..... | 47 |
| Call Lists..... | 48 |
| Using Speed Dials..... | 53 |
| Changing ACD States | 54 |
| Signing In | 54 |
| Going Unavailable | 55 |
| Going Available..... | 57 |
| Accepting a Call..... | 57 |
| Disposition Codes..... | 57 |
| Wrap-Up..... | 58 |
| Signing Out | 59 |
| Additional Features..... | 59 |
| Do Not Disturb (DND) | 59 |
| Factory Reset..... | 61 |

Installation

Desk Setup

NOTE: If you place the display face down when you attach the stand, be sure to place a soft cloth under the display to avoid any damage.

1. Insert the catches **(A)** of the stand into hooks located in the unit.
2. Gently push the stand in the direction indicated until it locks in place. The stand will be mounted in the high position by default.

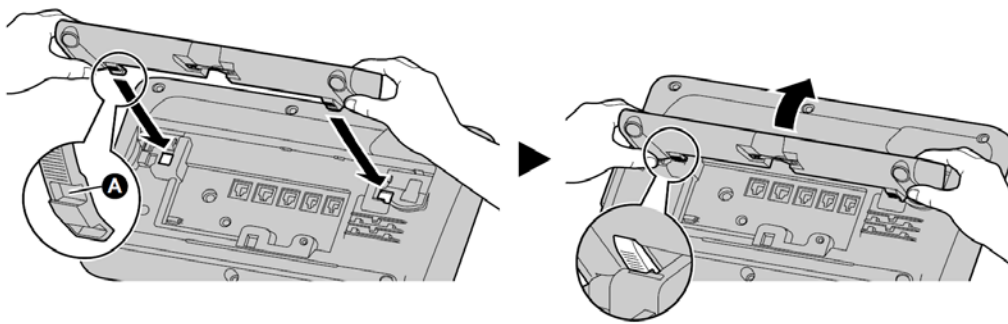

Figure 1-1: Attach the Stand

Adjusting from High to Low Position (*Figure 1-2*)

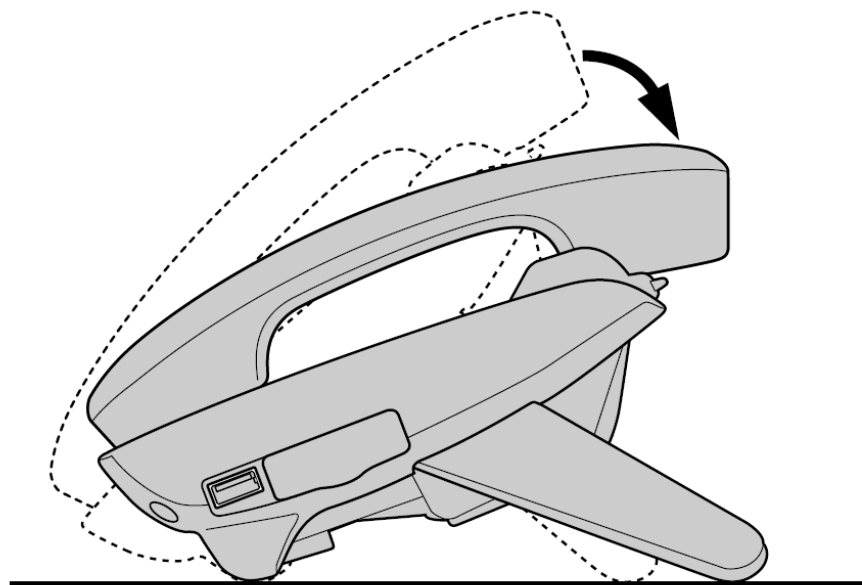

Figure 1-2: Position Adjustment 1

1. Tilt the stand in the direction indicated while pushing the PUSH mark with both hands as shown in *Figure 1-3* until it locks into the low position **(B)**.

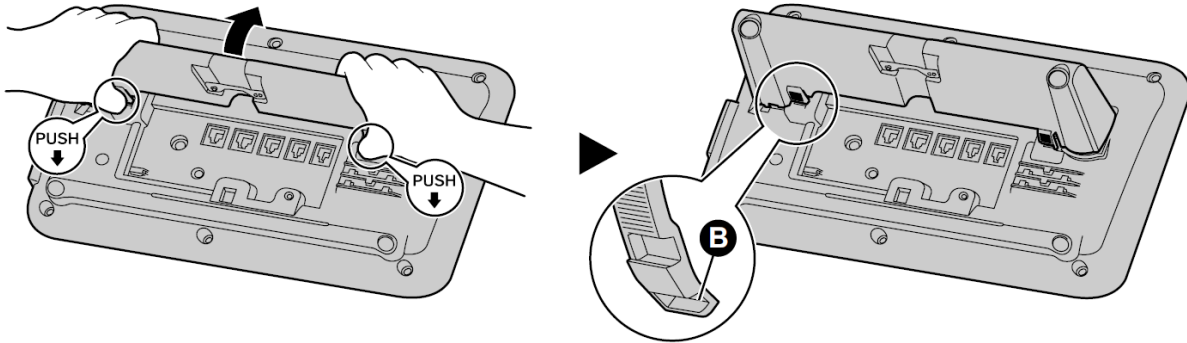

Figure 1-3: High to Low Adjustment

Adjusting from Low to High Position (*Figure 1-4*)

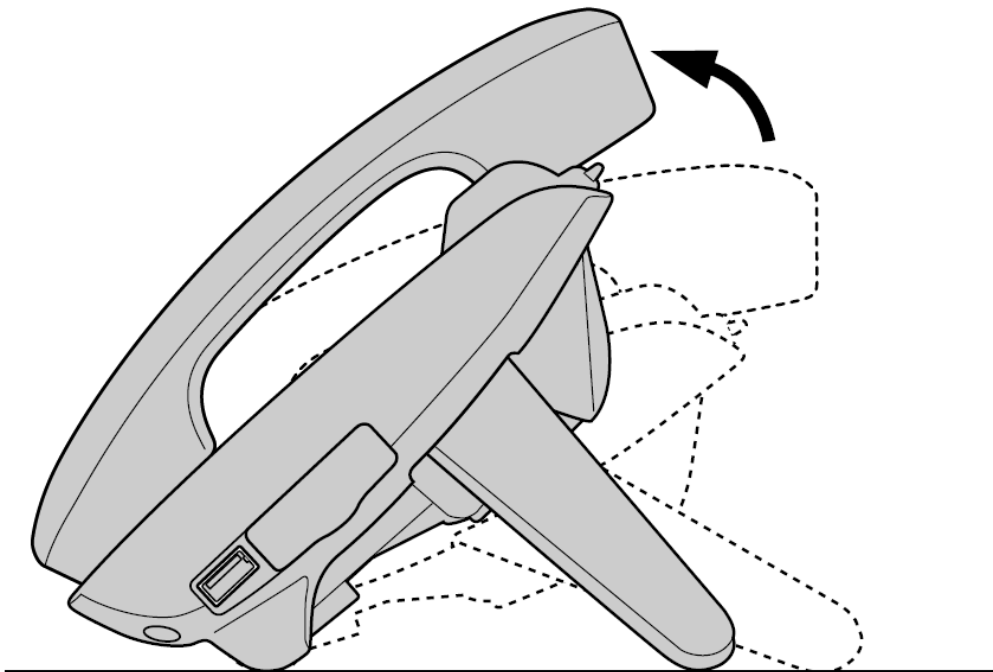
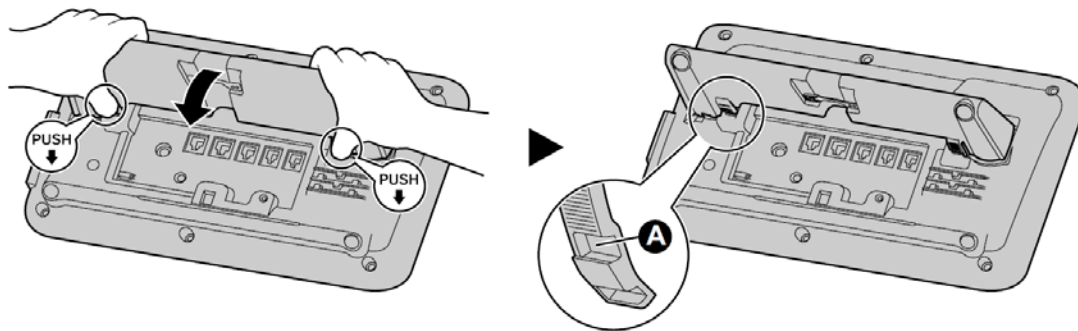

Figure 1-4: Position Adjustment 2

1. Tilt the stand in the direction indicated while pushing the PUSH mark with both hands as shown in *Figure 1-5* until it locks in the high position (A).



Connections for AC Adaptor/LAN/PC (Figure 1-6)

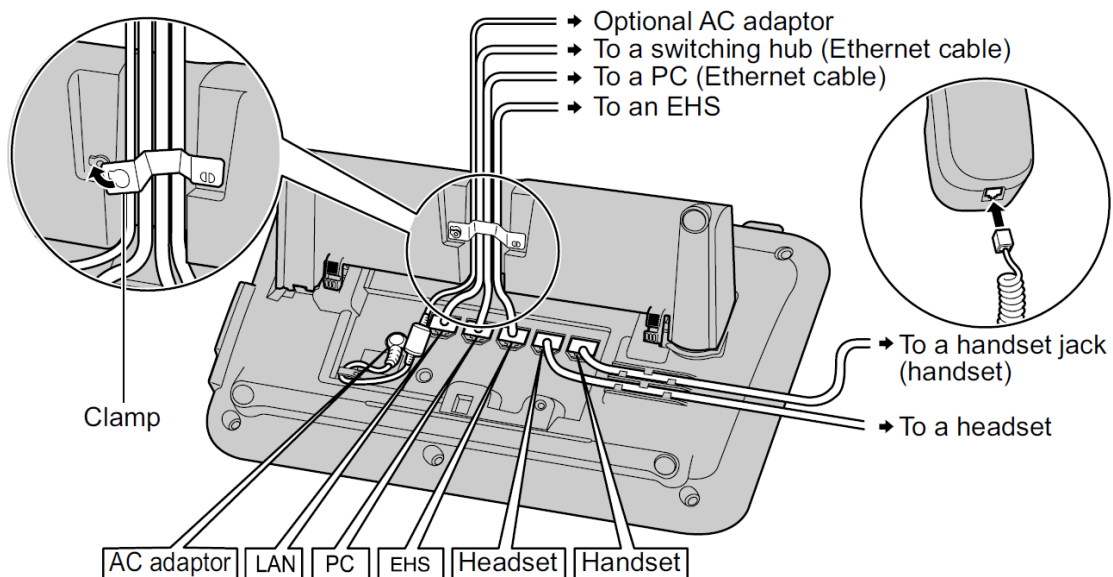

Figure 1-6: Cable Connections

- Use the following AC Adaptor: DSA-42D-48 2 480063
- When connecting a headset, the cord used to connect devices to the EHS jack or headset jack must be less than 3 meters (9.8 ft.) in length.
- Only 1 USB headset can be connected to the unit at a time.
- When connecting the Ethernet cable, connect the cables as shown in *Figure 1-7*.

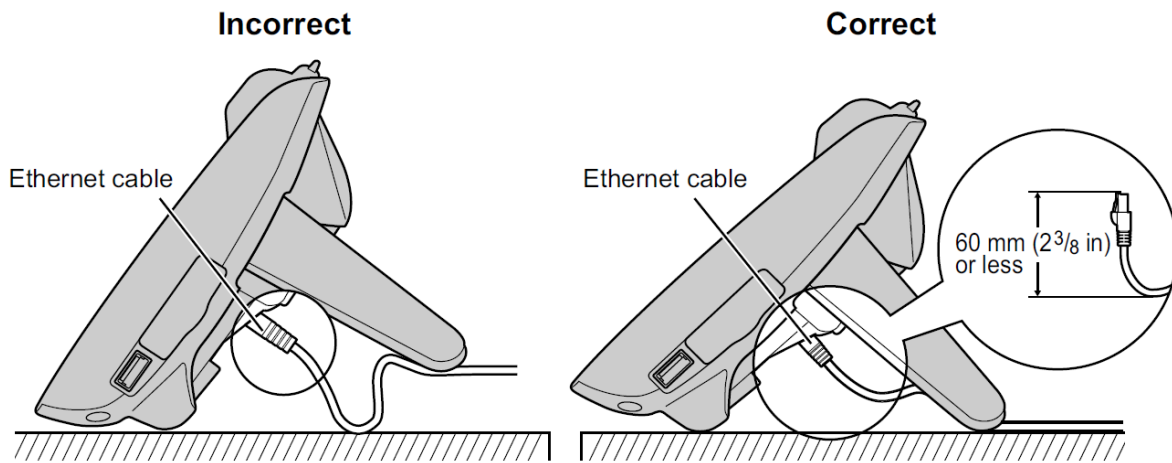

Figure 1-7: Proper Ethernet Connectivity

Connecting the Handset (Figure 1-8)

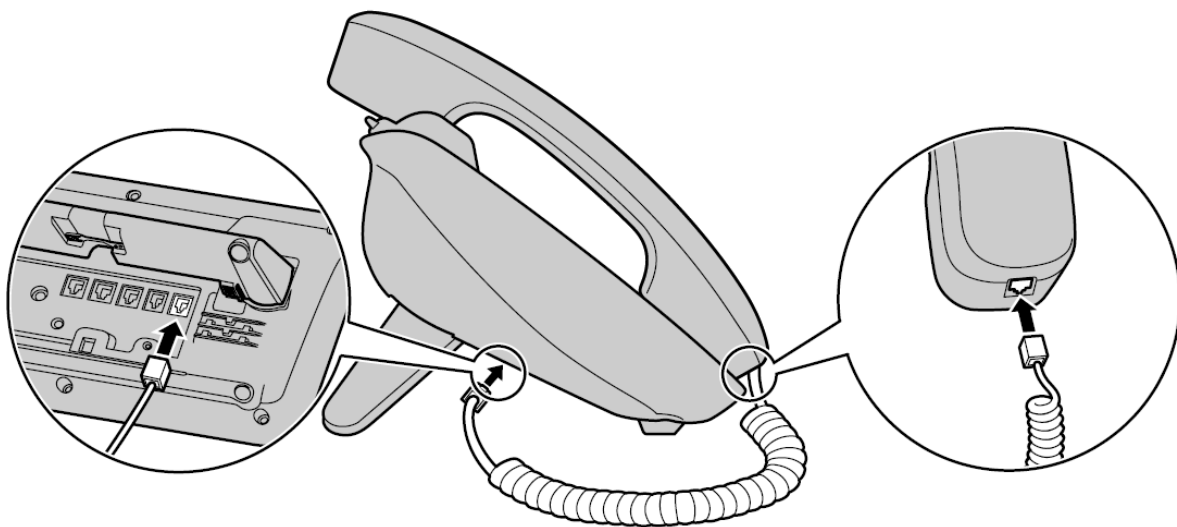

Figure 1-8: Handset Connection

Installing the Panasonic KX-UTA336 Sidecar

The optional Panasonic KX-UTA336 sidecar allows for 36 additional flexible buttons (3 pages of 12) to be used with the phone. These flexible buttons are used to make or receive calls, or perform a feature that has been assigned to the button. Flexible buttons for the Panasonic KX-UTA336 are configured and used in the same way as flexible buttons for the phone. A maximum of two Panasonic KX-UTA336 sidecars can be connected to the phone.

NOTE: An AC Adaptor must be used to supply power when the Panasonic KX-UTA336 sidecar is installed to the phone.

1. Remove any devices or cords connected to the USB port.
2. Remove the Add-on Key module slot cover **(1)** (*Figure 1-9*).



Figure 1-9: Add-on Key module slot cover

3. Connect the Panasonic KX-UTA336 **(1)** to the phone **(2)** by inserting the connector **(3)** into the Add-on Key module slot **(4)** (*Figure 1-10*).

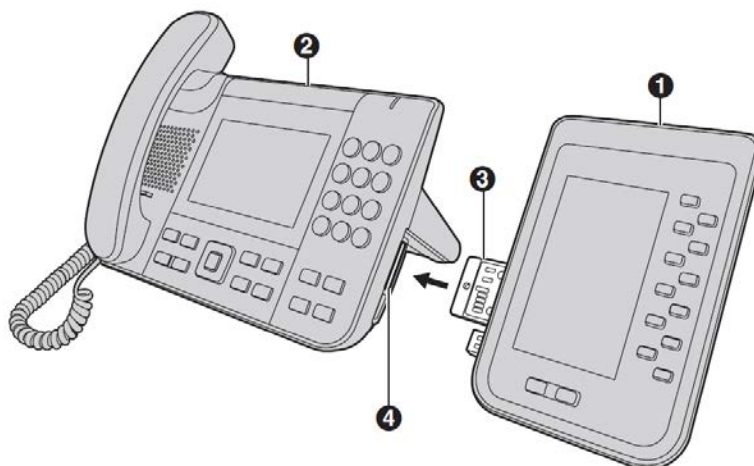

Figure 1-10: Connect the sidecar module

- Secure the Panasonic KX-UTA336 to the Panasonic KX-UTG 300B by inserting the 2 screws supplied with the Panasonic KX-UTA336 into the rear of the Panasonic KX-UTG-300B (*Figure 1-11*).

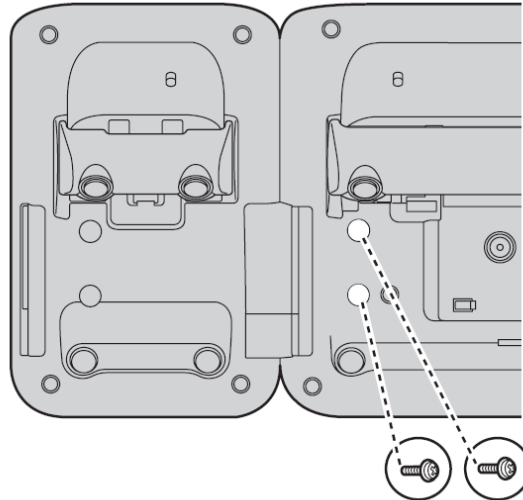

Figure 1-11: Secure the sidecar

Wall Mounting

NOTE: Make sure that the wall that the phone will be attached to is strong enough to support the phone. If not, it is necessary for the wall to be reinforced. If you place the display face down when you attach the stand, be sure to place a soft cloth under the display to avoid any damage.

- Insert the five tabs of the wall-mounting adaptor into the designated openings in the base, and then slide the wall-mounting adaptor in the direction of the arrow until it clicks (*Figure 1-12*).

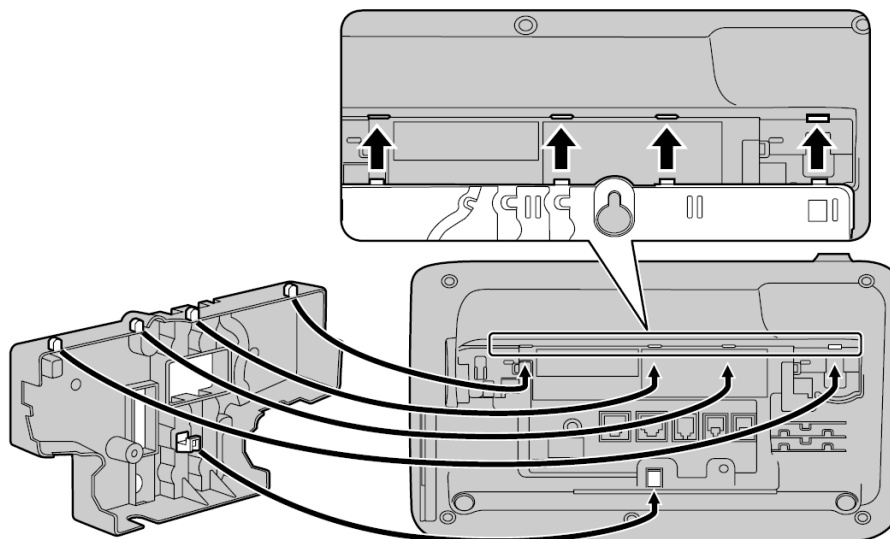

Figure 1-12: Attach wall mount

2. Fasten the wall-mounting adaptor to the base with 1 screw.
3. Connect the cables to the unit, and run the cables through the wall-mounting adaptor, as shown in *Figure 1-13*.

NOTE: The cables can also be run from the bottom of the unit.

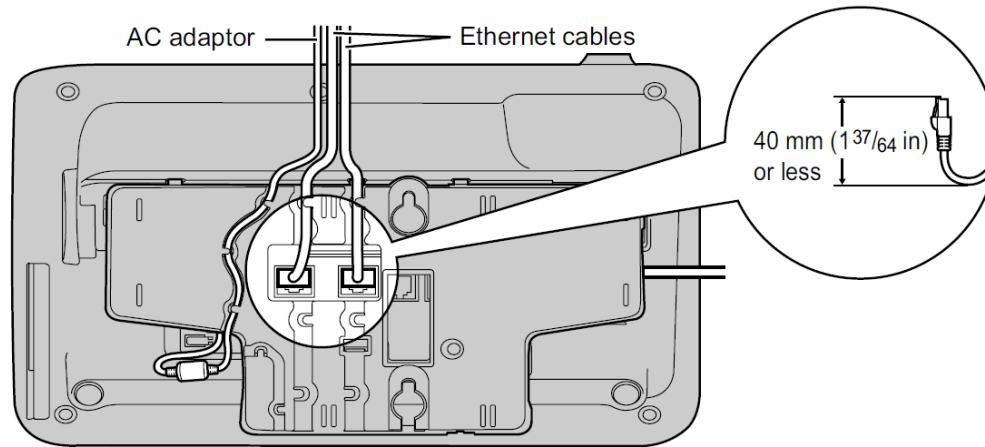

Figure 1-13: Run cables through wall mount

4. Drive the two screws into the wall 83 mm (3 and 1/4 in) or 100 mm (3 and 15/16 in) apart, and mount the phone on the wall.

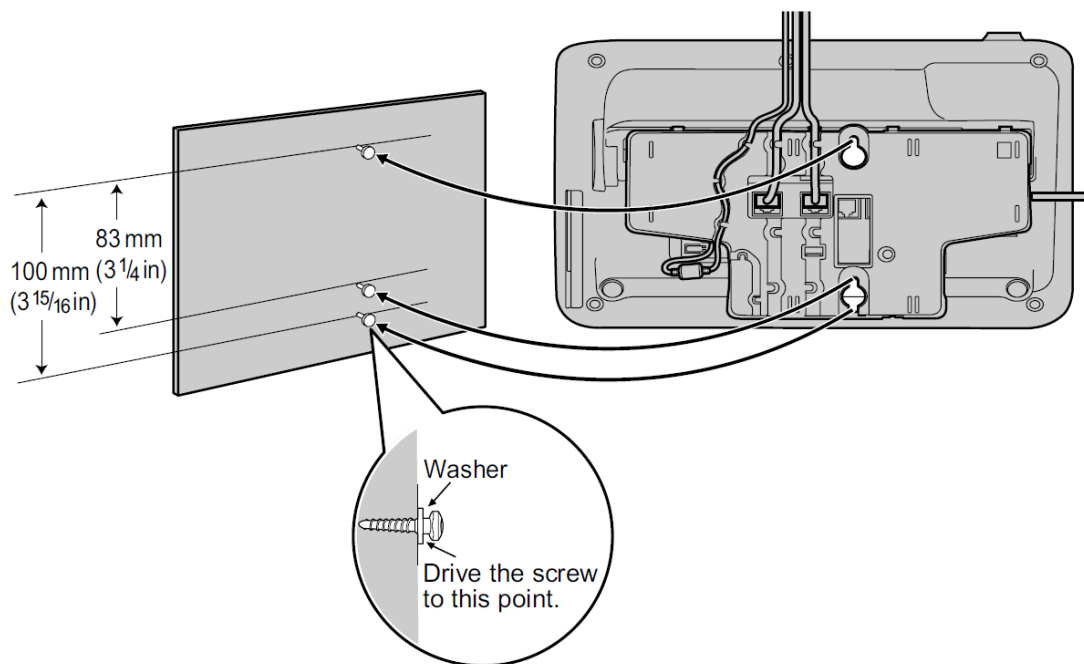

Figure 1-13: Hang on wall

Locking the Handset Hook when the Phone is Wall Mounted

1. Remove the handset hook from the slot (*Figure 1-14*).

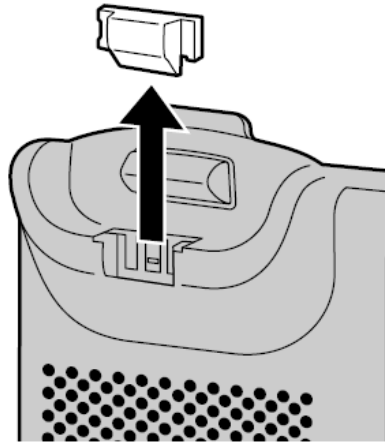

Figure 1-14: Remove handset hook

2. Turn it upside-down (*Figure 1-15*).

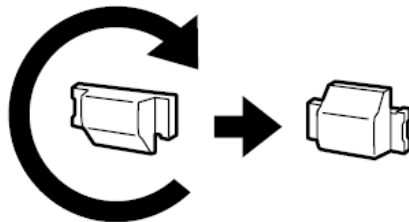

Figure 1-15: Flip hook upside-down

3. Slide the handset hook into the slot until it locks (*Figure 1-16*).

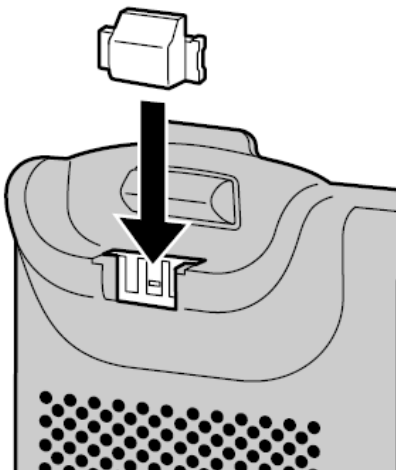

Figure 1-16: Re-insert handset hook

4. The handset will be safely hooked when it is in the cradle (*Figure 1-17*).

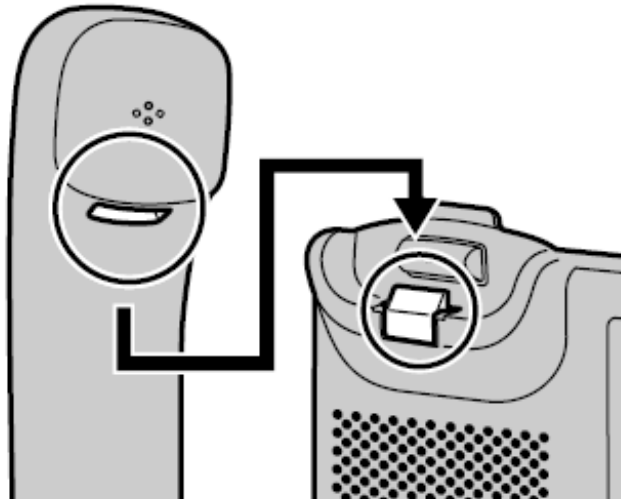
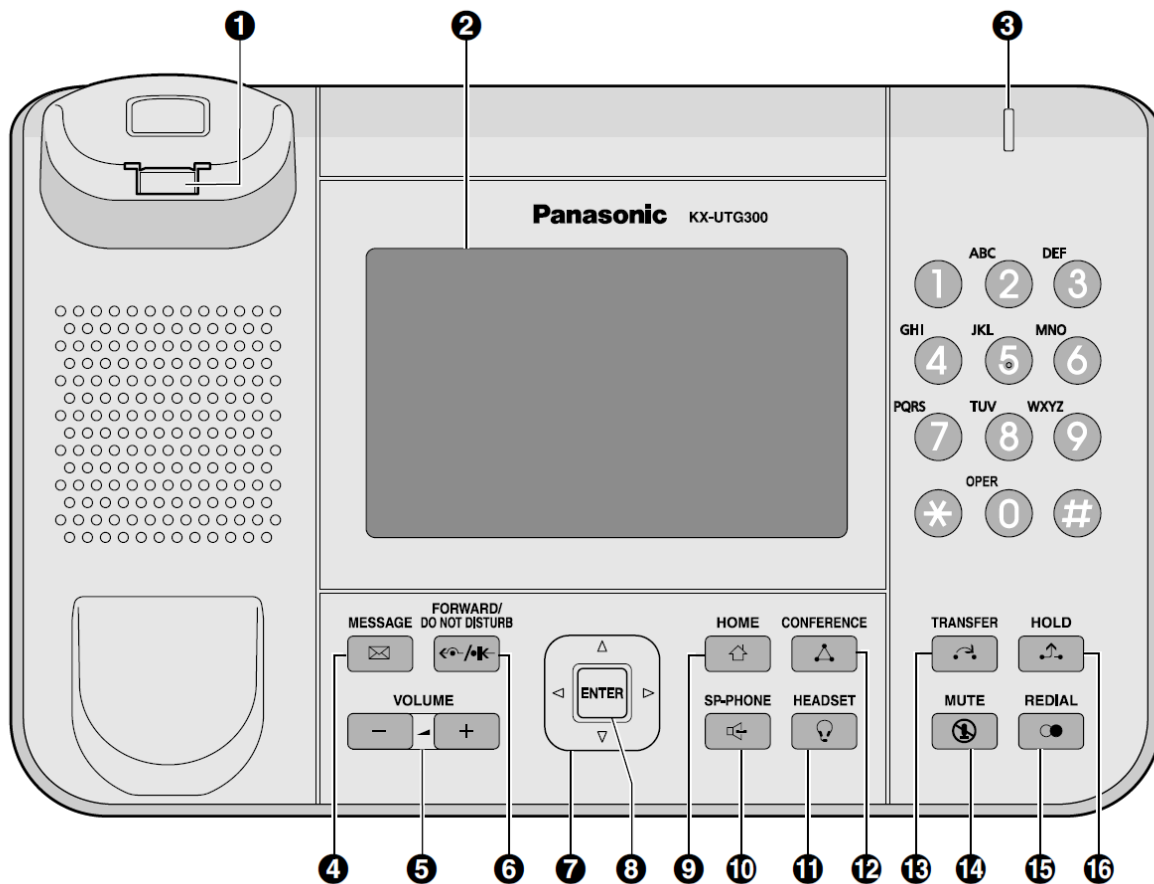

Figure 1-17: Handset hook operation

Location of Controls



Location of Controls Legend

- | | |
|---------------------------------|-----------------------------|
| 1. Handset Hook | 9. HOME |
| 2. LCD (Liquid Crystal Display) | 10. SP-PHONE (Speakerphone) |
| 3. Message/Ringer Lamp | 11. HEADSET |
| 4. MESSAGE | 12. CONFERENCE |
| 5. VOLUME | 13. TRANSFER |
| 6. FORWARD/DO NOT DISTURB | 14. MUTE |
| 7. Navigator Key | 15. REDIAL |
| 8. ENTER | 16. HOLD |

Provisioning Instructions

Assigning the Phone to a User using the NextOS 3.0 Beta Portal

1. For Administrators, log in to the NextOS 3.0 Beta portal by visiting www.nextiva.com and clicking on the customer Login link found at the top right.
2. Log in to the NextOS 3.0 portal on the right side of the screen with your login credentials.
3. From the main dashboard, click **Add** in the **Devices** tile (*Figure 3-1*).

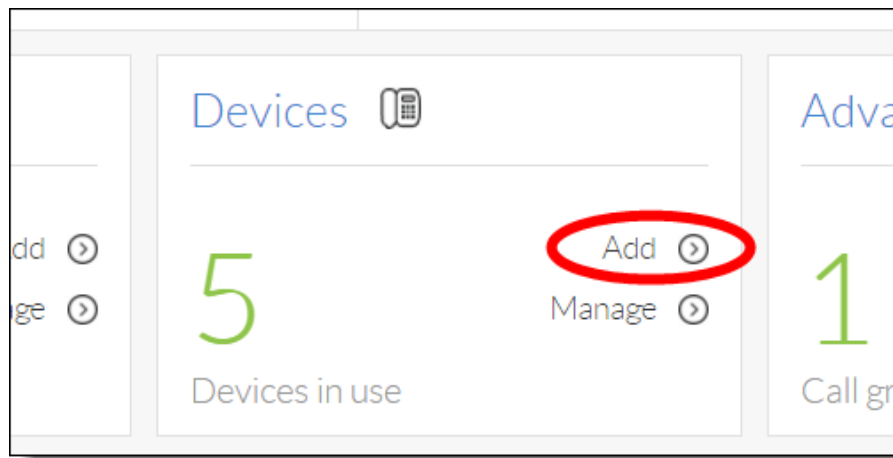

Figure 3-1: Add Device

4. If the Panasonic KX-UTG 300B was purchased from Nextiva, select **Nextiva device** at the top of the screen, and then select the model and MAC address of the phone in the corresponding drop-down lists. If you did not purchase the phone from Nextiva, select **Own device** at the top of the screen (*Figure 3-3*).

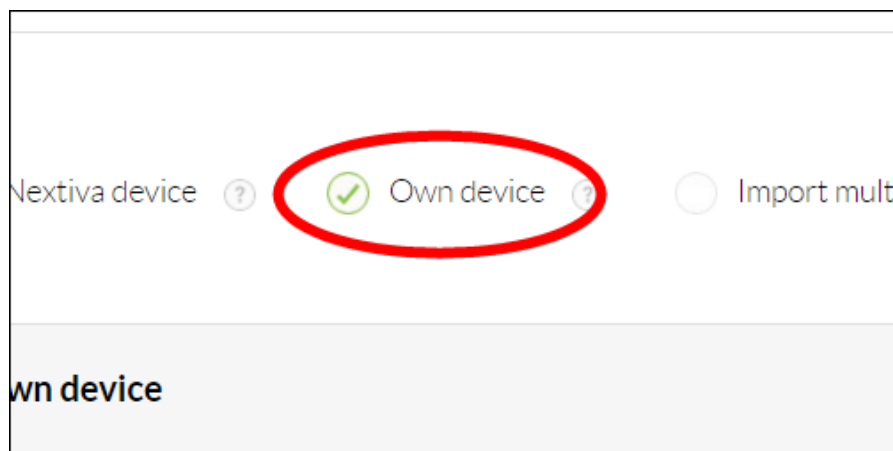

Figure 3-2: Select Own Device

5. Select **Panasonic KX-UTG 300B** as the model from the Select model drop-down list (*Figure 3-3*).

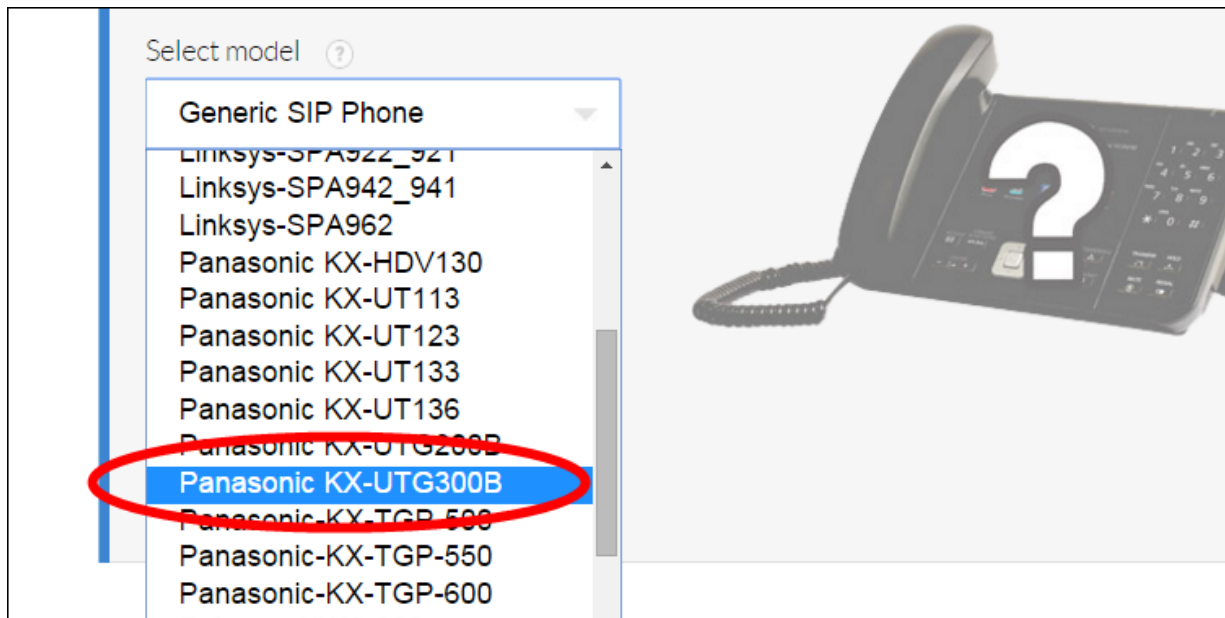

Figure 3-3: Select Model

6. Enter the MAC address found on the base unit in the MAC Address text box (*Figure 3-4*).

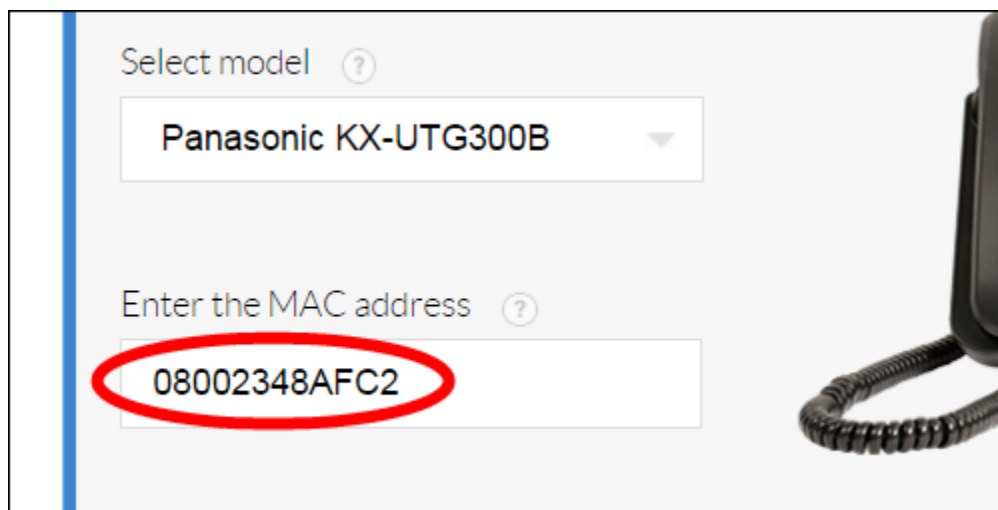

Figure 3-4: Enter MAC Address

7. Click the blue **Assign** button (Figure 3-5).

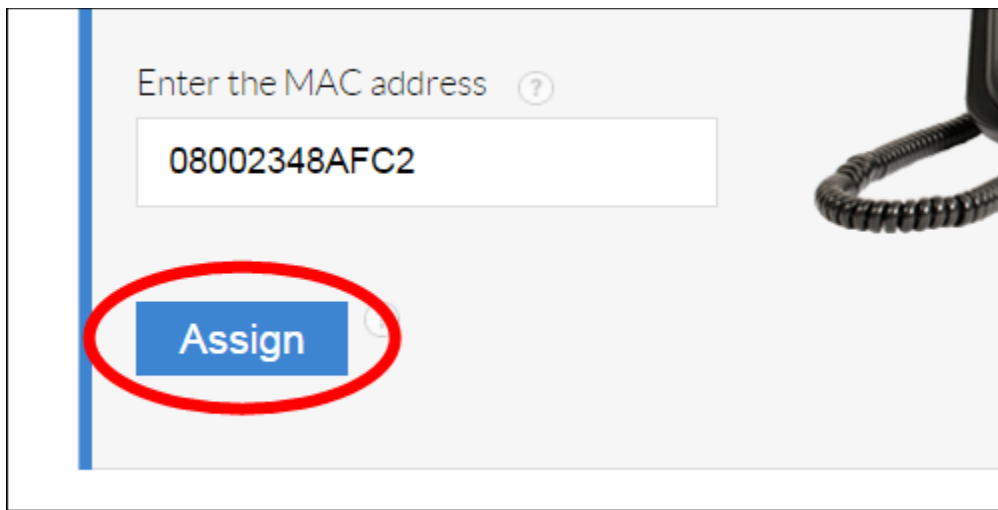

Figure 3-5: Assign Device

8. A pop-up message appears confirming the device was successfully provisioned. Click the **X** in the upper-right corner of the pop-up message to close it.

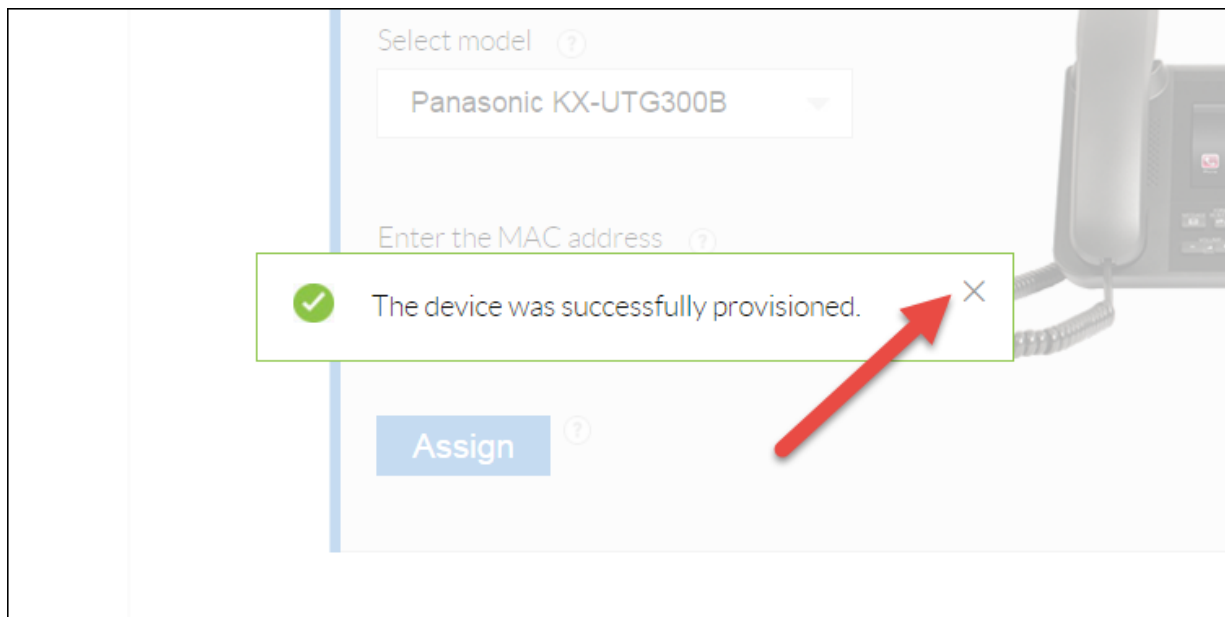
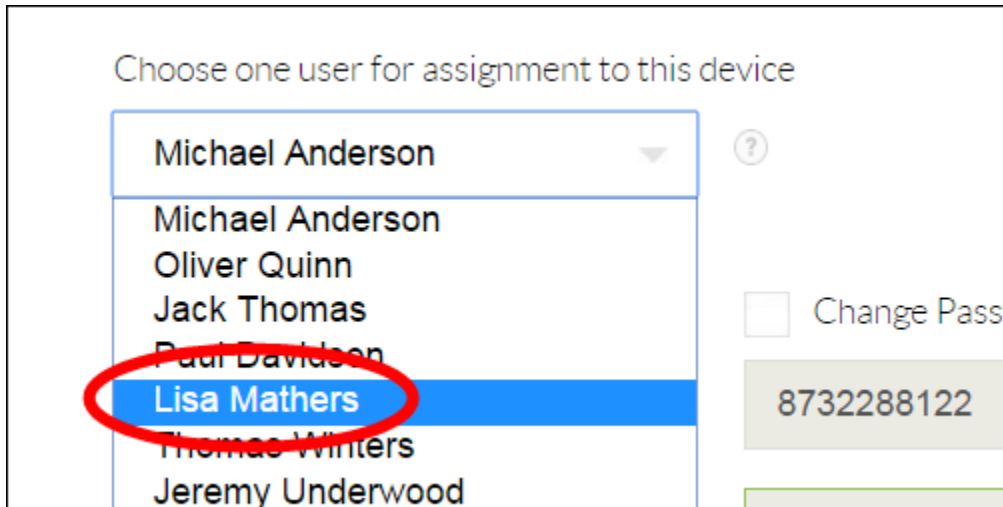

Figure 3-6: Confirmation Message

Now you will need to assign the Panasonic KX-UTG 300B to a user.

9. Select the user from the drop-down list to whom you want to assign the Panasonic KX-UTG 300B device (Figure 3-7).



Choose one user for assignment to this device

Michael Anderson

Michael Anderson

Oliver Quinn

Jack Thomas

Paul Davidson

Lisa Mathers

Thomas Winters

Jeremy Underwood

Change Password

8732288122

Generate

Figure 3-7: Select the User

10. Click the green **Generate** button under the **Authentication Name** text box to generate an authentication name.

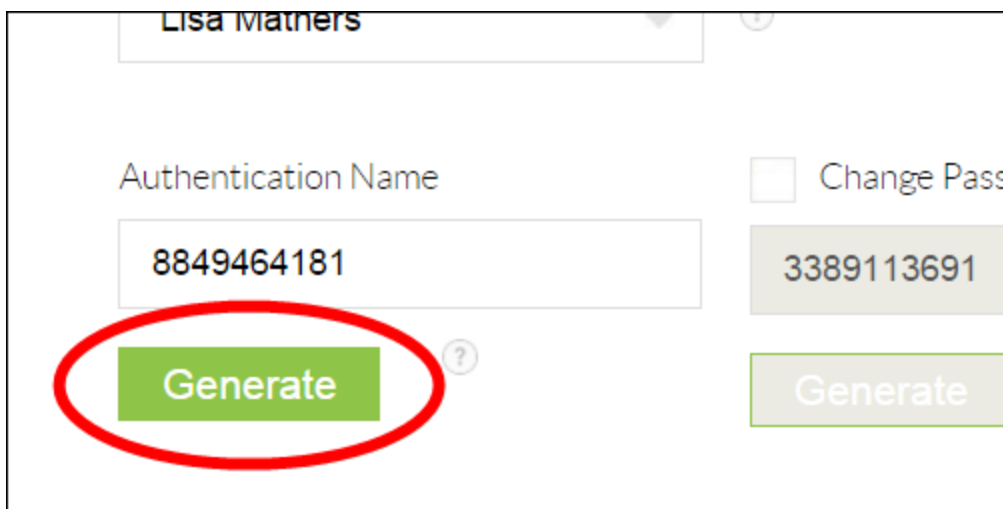

Lisa Mathers

Authentication Name

8849464181

Change Password

3389113691

Generate

Generate

Figure 3-8: Generate Authentication Name

11. Select **Change Password**, and then click the green **Generate** button to generate a new password (Figure 3-9).

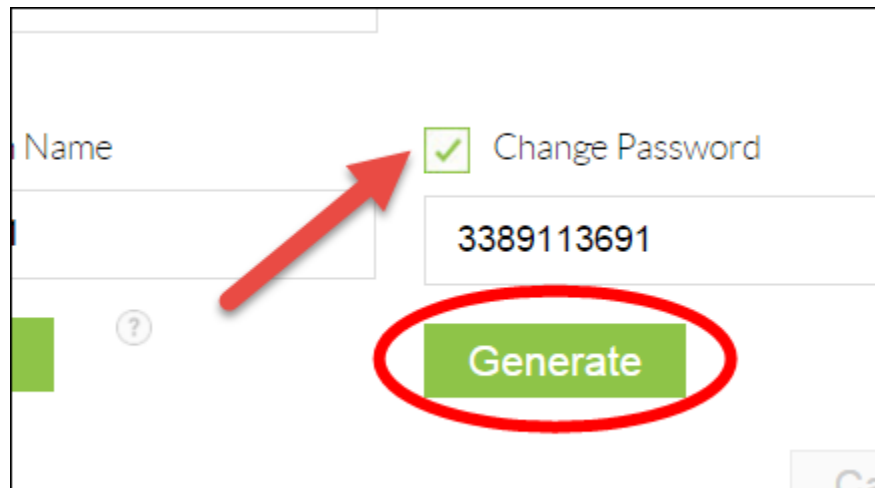

Figure 3-9: Generate a Password

12. Click the green **Finish** button at the bottom of the screen. A pop-up message appears saying the user was successfully assigned to the device. Click the **X** in the upper-right corner of the pop-up message to close it (Figure 3-10).

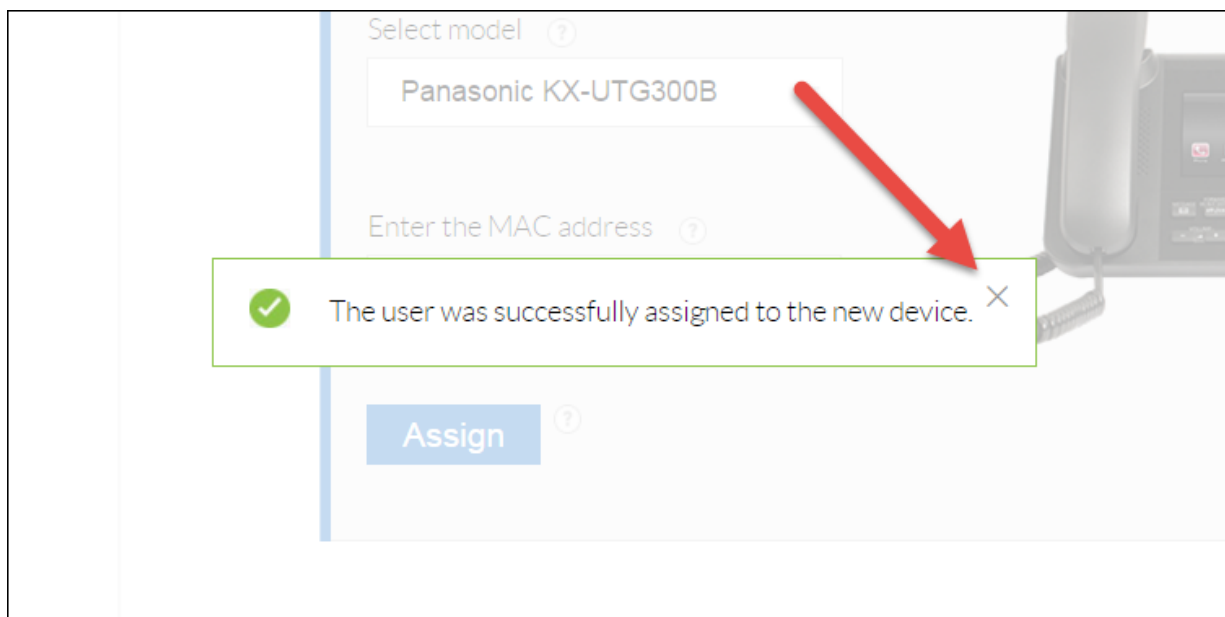

Figure 3-10: Confirmation Message

Checking the Firmware

The Panasonic KX-UTG 300B should be on Firmware 03.137. The steps below detail how to upgrade the firmware if necessary.

1. Enable the Web Configuration Utility and obtain the IP address of the phone. Select the **Menu** softkey, and then select **Settings** and press **#534** on the keypad to enable embedded web. Next, select the **Menu** softkey again, and then select **Settings** and locate **Information Display** to locate your phones IP Address.
2. Enter the IP address of the phone into the address bar of a **web browser** (Internet Explorer, Firefox, Chrome, etc.) (Figure 3-11).

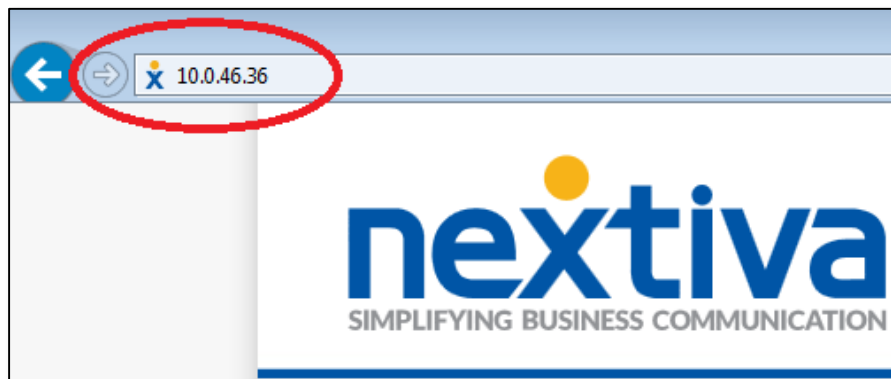

Figure 3-11: Navigate to the Phone's IP Address

3. Login with **admin** for the username and **adminpass** for the password (Figure 3-12).

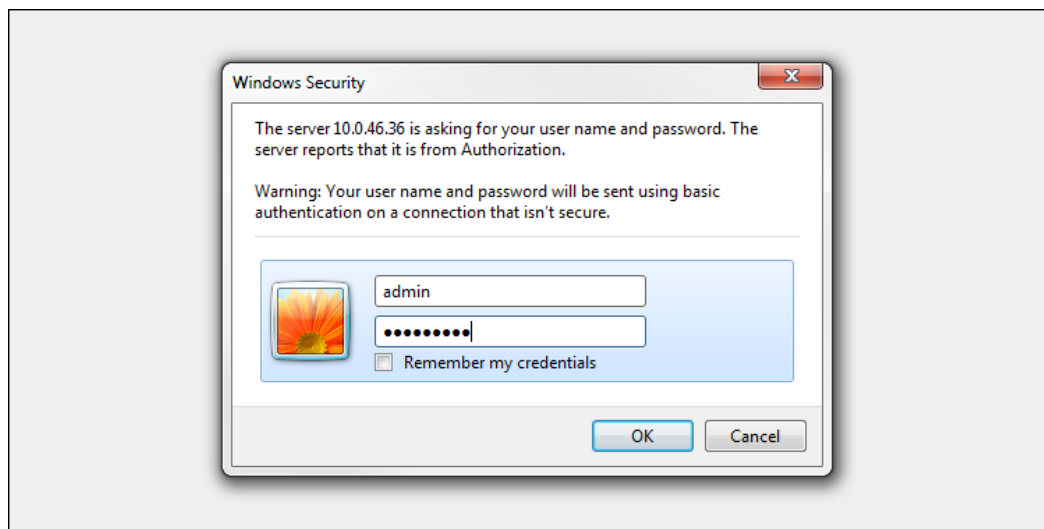

Figure 3-12: Log In to Phone Interface

After logging in, the current firmware displays on the screen. First, determine which Bank the Panasonic KX-UTG 300B phone is using by viewing the **Operating Bank** field. Then, determine what firmware that bank contains – it should be **03.137** (Figure 3-13).

| Version Information | |
|--------------------------|------------|
| Model | KX-UTG300B |
| Operating Bank | Bank2 |
| Firmware Version (Bank1) | 02.123 |
| Firmware Version (Bank2) | 03.137 |

Figure 3-13: Check the Firmware

If the firmware is not correct, follow the instructions below to upgrade the firmware.

1. Click the **Maintenance** tab at the top of the screen (Figure 3-14).

| Version Information | |
|---------------------|------------|
| Model | KX-UTG300B |
| Bank | Bank2 |
| Version (Bank1) | 02.123 |
| Version (Bank2) | 03.137 |

Figure 3-14: Maintenance Tab

2. Click **Firmware Maintenance** on the left side of the screen (Figure 3-15).

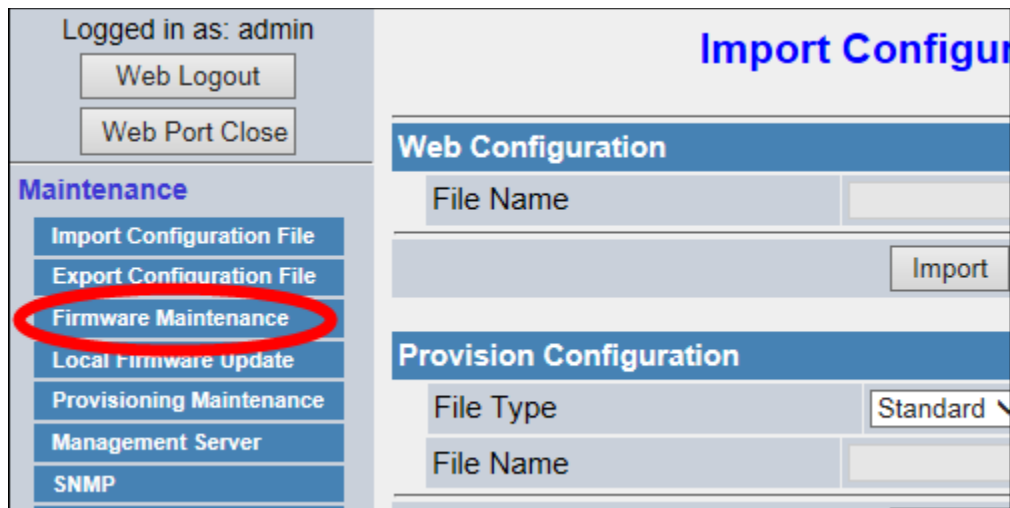

The screenshot shows a web interface for 'Import Configuration'. On the left, a 'Maintenance' menu is visible with several options: 'Import Configuration File', 'Export Configuration File', 'Firmware Maintenance' (circled in red), 'Local Firmware Update', 'Provisioning Maintenance', 'Management Server', and 'SNMP'. The main content area is titled 'Import Configuration' and contains two sections: 'Web Configuration' with a 'File Name' input field and an 'Import' button, and 'Provision Configuration' with a 'File Type' dropdown menu set to 'Standard' and a 'File Name' input field.

Figure 3-15: Firmware Maintenance

3. Make sure that **Enable Firmware Update** is set to **Yes**, and then enter **http://dm.nextiva.com:80/dms/Nextiva_Service_Provider/KXUTG300B/firmware3.117.bin** in the **Firmware File URL** text box (Figure 3-16).

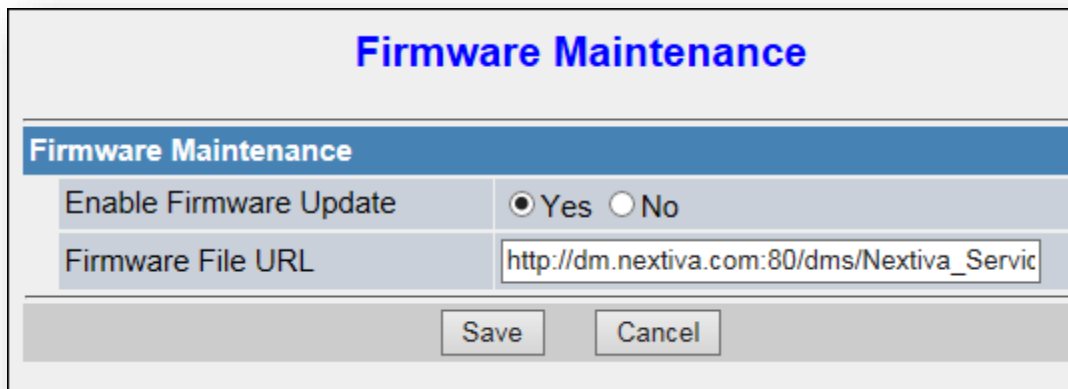

The screenshot shows the 'Firmware Maintenance' configuration page. The title is 'Firmware Maintenance'. Below the title, there are two rows of configuration options. The first row is 'Enable Firmware Update' with radio buttons for 'Yes' (selected) and 'No'. The second row is 'Firmware File URL' with a text box containing the URL 'http://dm.nextiva.com:80/dms/Nextiva_Servic'. At the bottom of the page, there are 'Save' and 'Cancel' buttons.

Figure 3-16: Enter Firmware URL

4. Click **Save** at the bottom of the screen (Figure 3-17).

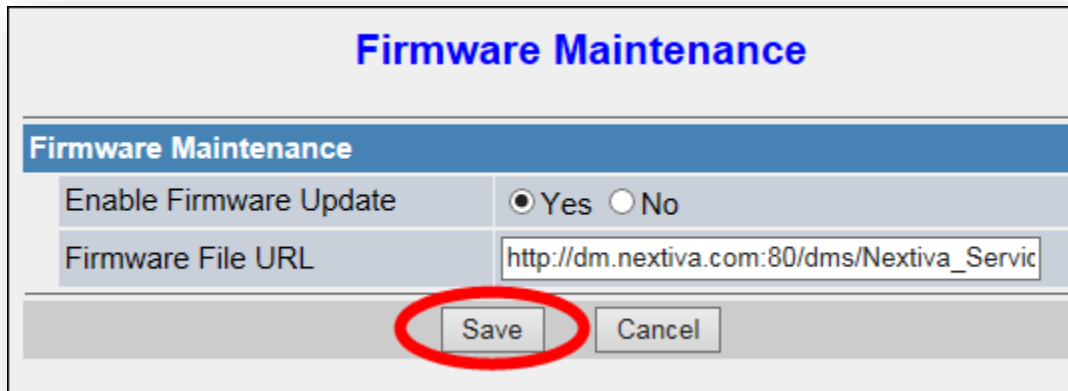

| Firmware Maintenance | |
|---|--|
| Enable Firmware Update | <input checked="" type="radio"/> Yes <input type="radio"/> No |
| Firmware File URL | <input type="text" value="http://dm.nextiva.com:80/dms/Nextiva_Servic"/> |
| <input type="button" value="Save"/> <input type="button" value="Cancel"/> | |

Figure 3-17: Save Changes

Entering the Provisioning Server

1. Enable the Web Configuration Utility and obtain the IP address of the phone. Select the **Menu** softkey, and then select **Settings** and press **#534** on the keypad to enable embedded web. Next, select the **Menu** softkey again, and then select **Settings** and locate **Information Display** to locate your phones IP Address.
2. Enter the IP address of the phone into the address bar of a **web browser** (Internet Explorer, Firefox, Chrome, etc.) (Figure 3-18).

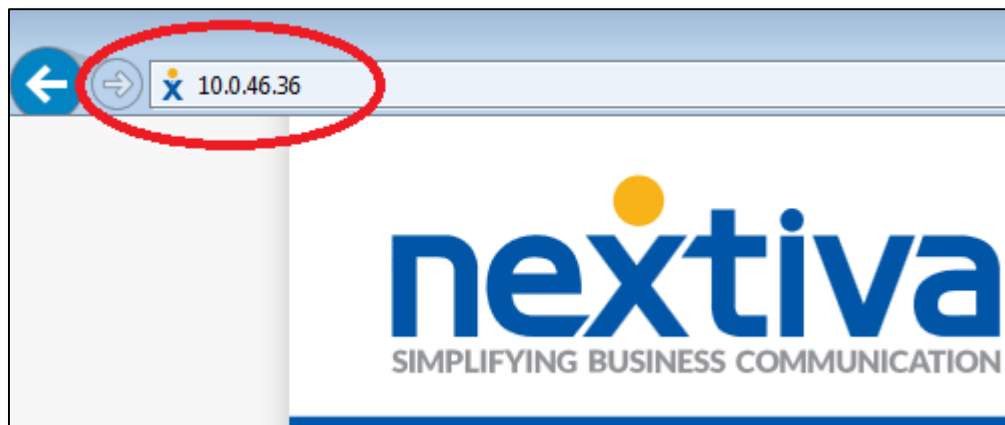

Figure 3-18: Navigate to the Phone's IP Address

3. Login with **admin** for the username and **adminpass** for the password (Figure 3-19).

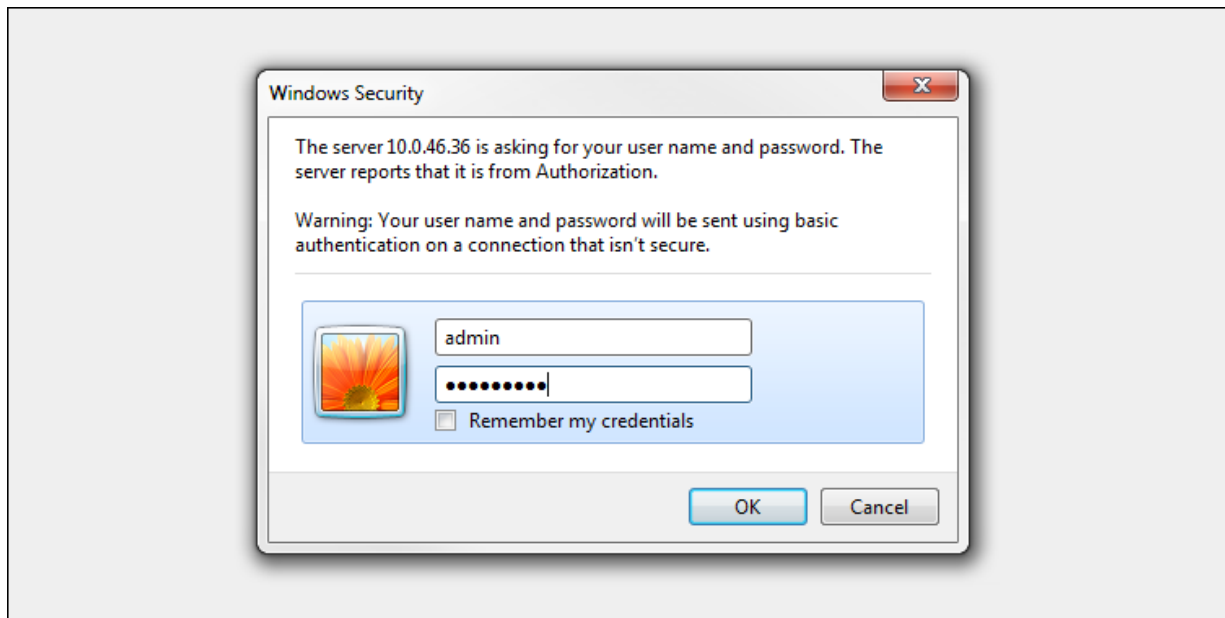

Figure 3-19: Log In to Phone Interface

4. Click the **Maintenance** tab at the top of the screen (Figure 3-20).

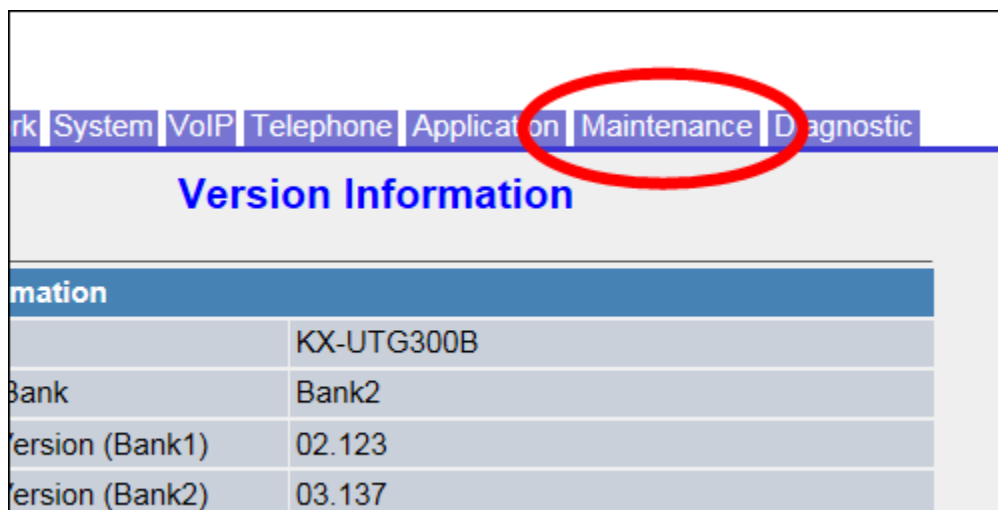

Figure 3-20: Maintenance Tab

- Click **Provisioning Maintenance** on the left side of the screen (Figure 3-21).

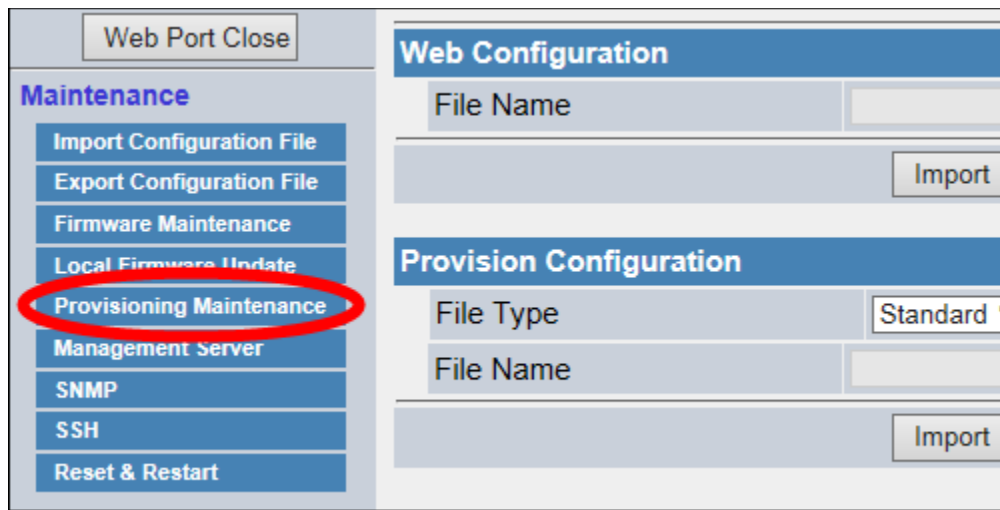

Figure 3-21: Provisioning Maintenance

- Make sure that **Enable Provisioning** is set to **Yes**, and then enter **http://dm.nextiva.com:80/dms/Nextiva_Service_Provider/KXUTG300B/** in the **Provision Server** text box (Figure 3-22).

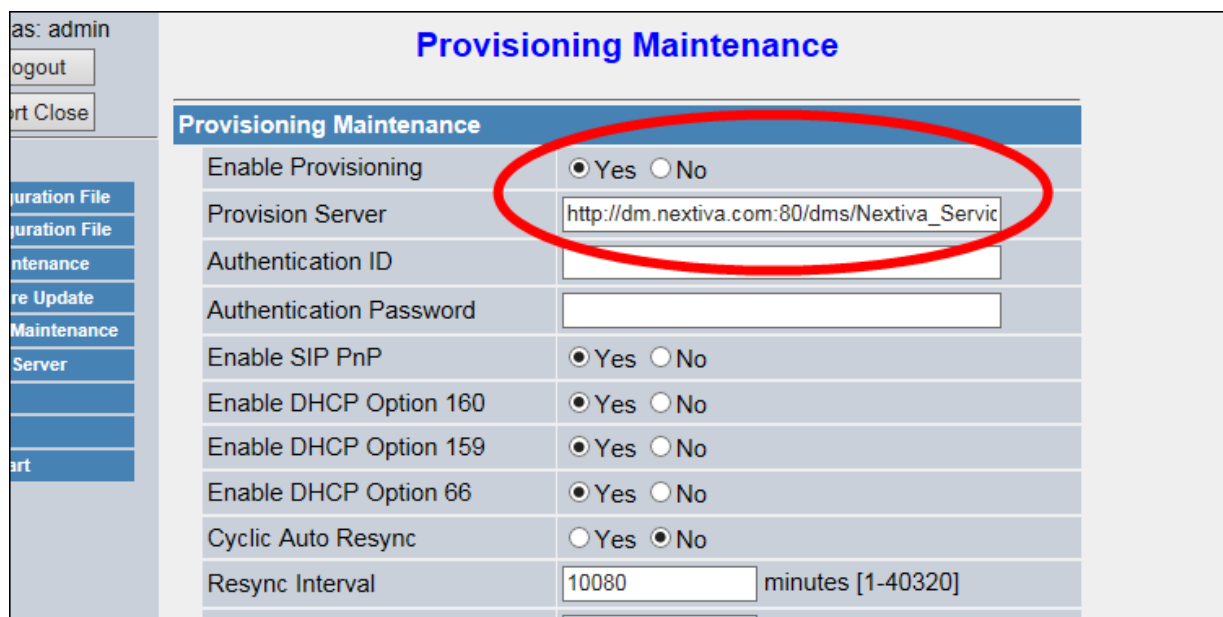

Figure 3-22: Provisioning Information

7. Click **Save** at the bottom of the screen. After a few minutes, the phone will provision and register, which is necessary to make and receive calls (Figure 3-23).

| | |
|--|---|
| Enable DHCP Option 66 | <input checked="" type="radio"/> Yes <input type="radio"/> No |
| Cyclic Auto Resync | <input type="radio"/> Yes <input checked="" type="radio"/> No |
| Resync Interval | <input type="text" value="10080"/> minutes [1-40320] |
| Header Value for Resync Event | <input type="text" value="check-sync"/> |
| <input checked="" type="button" value="Save"/> <input type="button" value="Cancel"/> | |
| Resync Configuration Files | |
| <input type="button" value="Resync"/> | |

Figure 3-23: Save Changes

Enabling the Web Configuration Utility

1. Press the **HOME** button on the bottom of the phone.
2. Select the **Settings** icon toward the bottom of the screen (Figure 3-24).

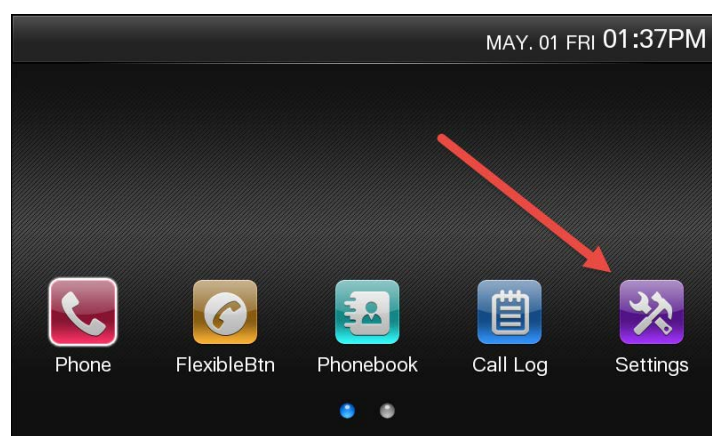

Figure 3-24: Settings

- Using the silver navigation pad at the bottom of the phone, scroll down to the **Network Settings** option (*Figure 3-25*).

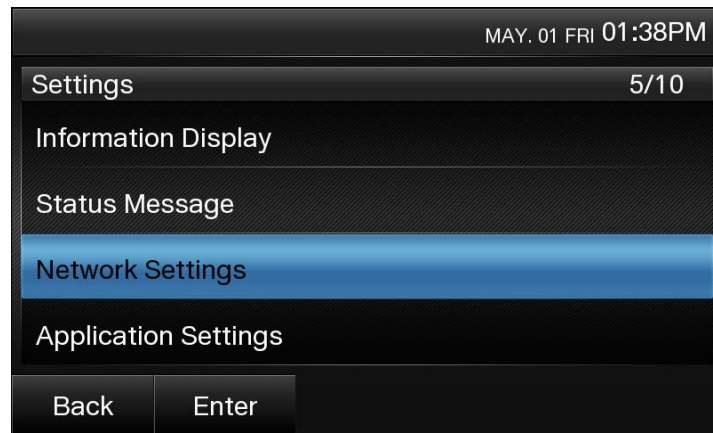

Figure 3-25: Network Settings

- Select **Enter** on the screen, or press the **ENTER** button in the middle of the silver navigation pad.
- Using the silver navigation pad, scroll down to the **Embedded Web** option.
- Select **On** at the bottom of the screen, or press the **ENTER** button in the middle of the silver navigation pad. Embedded Web will now display as **On** (*Figure 3-26*).

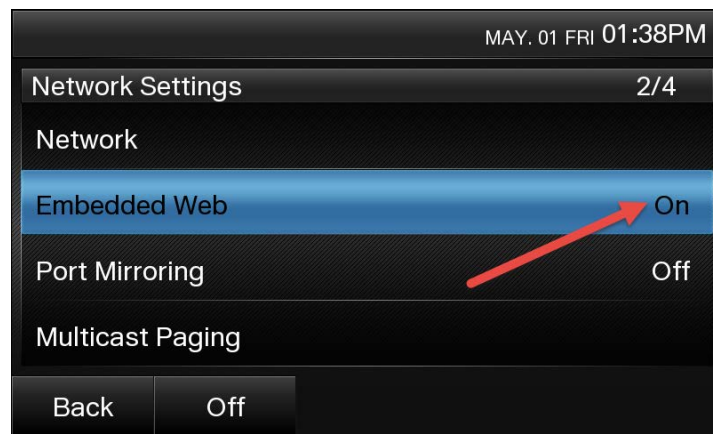

Figure 3-26: Set Embedded Web to On

- Select **Back** on the bottom of the screen to go back to the main **Settings** menu.

- Using the silver navigation pad, scroll up to the **Information Display** option (*Figure 3-27*).

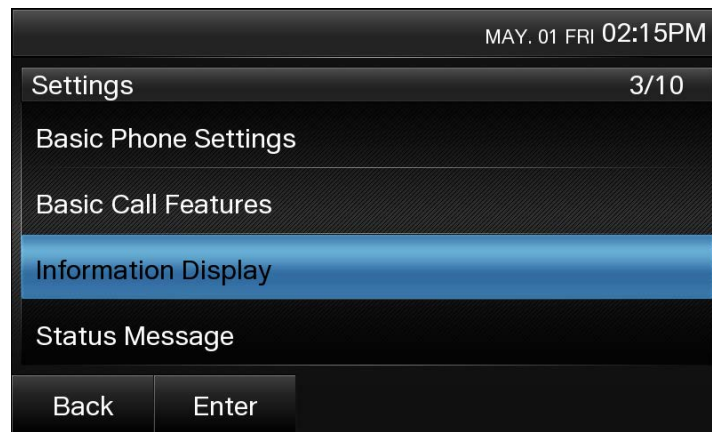

Figure 3-27: Information Display

- Select **Enter** at the bottom of the screen, or press the **ENTER** button in the middle of the silver navigation pad. The IP address of the phone will display on the screen (*Figure 3-28*).

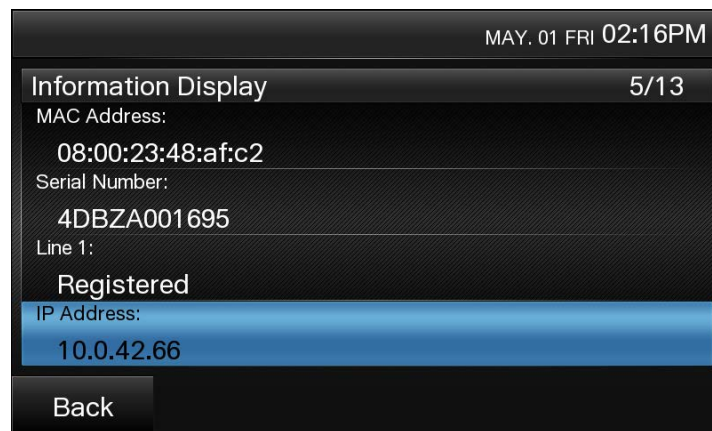

Figure 3-28: IP Address

Additional Setup Options

Correcting the Time

NOTE: Make sure the time zone in the NextOS 3.0 portal is correct for the user before proceeding.

The Panasonic KX-UTG 300B cannot have its time changed on the local phone. Please call Nextiva Support to ensure your phone's configuration file reflects the proper time zone.

Line Mirroring

The Panasonic KX-UTG 300B automatically integrates this feature into its software. Additional inbound calls will automatically rollover to the next available line.

Busy Lamp Field (BLF)

Busy Lamp Field (BLF) is a service that allows a user to see/monitor (from their phone) whether another user is on the phone or not. This feature is commonly used by administrative assistants for ease of call transfer, and by call center managers to assist in monitoring their employees. If you would like to set up BLF on your phone, please contact Nextiva Support.

Directories

Remote directories are not supported on the Panasonic KX-UTG 300B.

Speed Dials

From the Phone

1. Dial ***75** from the phone.
2. After the phone beeps, enter the two-digit number to be used for the speed dial, and then the phone number or extension, followed by #.

EXAMPLE: To set up the number 02 as a speed dial to 4805551234, enter 02, then 4805551234, then # (**024805551234#**).

3. Hang up.

To use speed dials, go **off-hook** with your phone. Enter #, followed by the speed dial number (ex. #02) to connect to the assigned phone number. If the speed dial number is lower than 10, you must enter the 0 preceding the number to create a two-digit number. If you are using a softphone, dial #, followed by the speed dial number, and then press the dial button.

NOTE: In this guide **off-hook** is used to describe when a phone is in use or has a dial tone before a call is made. **On-hook** describes when a phone is idle.

From the Web Configuration Utility

1. Enable the Web Configuration Utility and obtain the IP address of the phone. Select the **Menu** softkey, and then select **Settings** and press **#534** on the keypad to enable embedded web. Next, select the **Menu** softkey again, and then select **Settings** and locate **Information Display** to locate your phones IP Address.
2. Enter the IP address of the phone into the address bar of a **web browser** (Internet Explorer, Firefox, Chrome, etc.)(*Figure 4-1*).

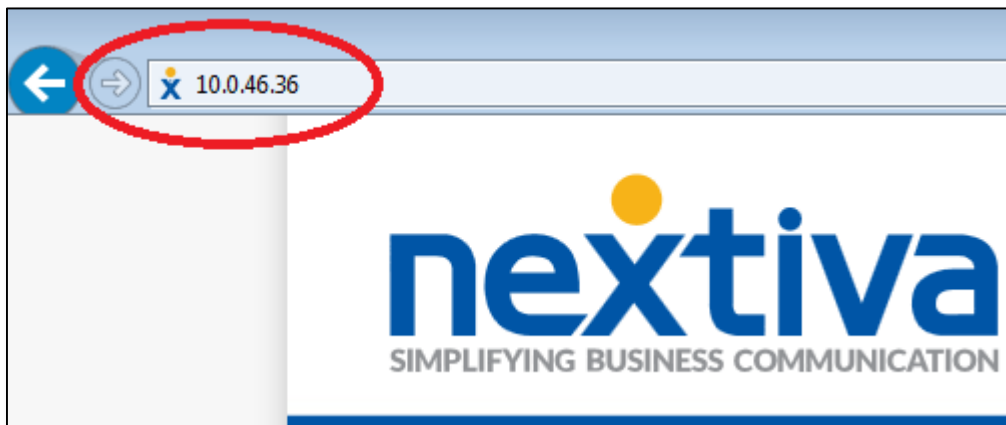

Figure 4-1: Navigate to the Phone's IP Address

3. Login with **admin** for the username and **adminpass** for the password (Figure 4-2).

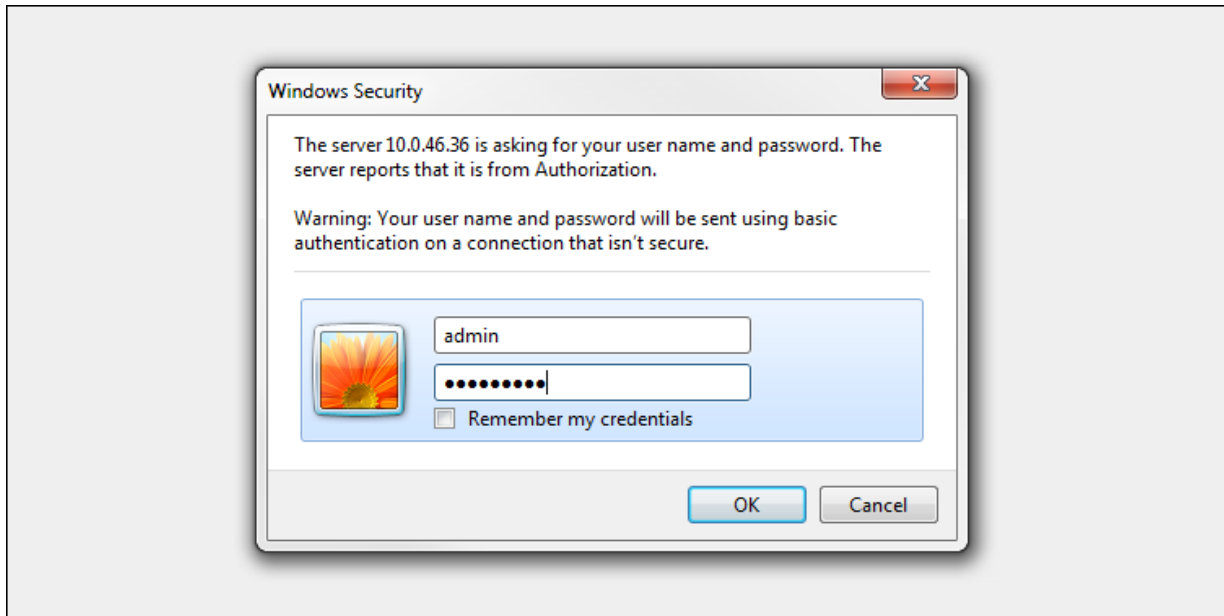

Figure 4-2: Log In to Phone Interface

4. Click the **Telephone** tab at the top of the screen (Figure 4-3).

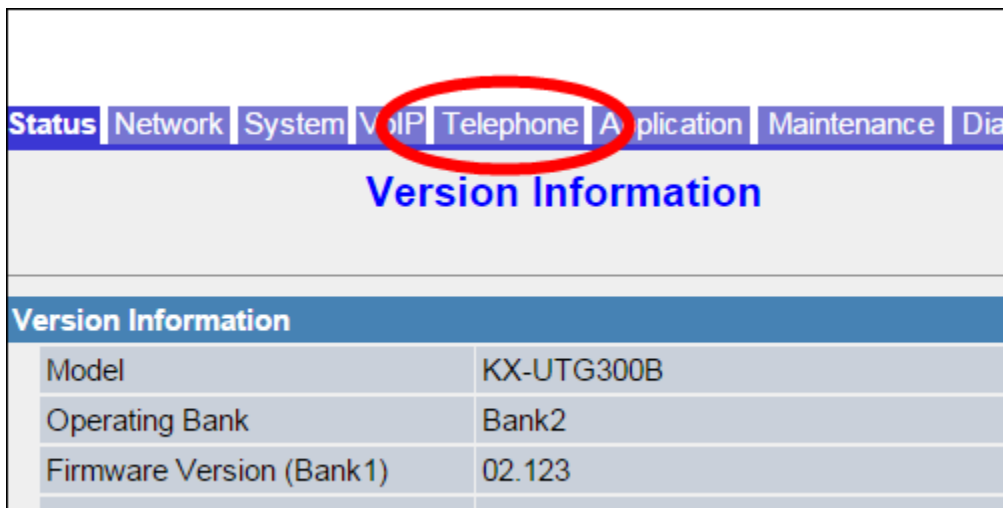

Figure 4-3: Telephone Tab

5. Click **Flexible Button Settings** on the left side of the screen (Figure 4-4).

| | | |
|--------|-------------------------------------|----------------------|
| -Line2 | Hold Recall Timer | 60 |
| -Line3 | Default Line | 1 ▼ |
| -Line4 | Call Rejection Phone Numbers | |
| -Line5 | 1 | <input type="text"/> |
| | 3 | <input type="text"/> |
| | 5 | <input type="text"/> |
| | 7 | <input type="text"/> |
| | 9 | <input type="text"/> |
| | 11 | <input type="text"/> |

Figure 4-4: Flexible Button Settings

6. Fill in the fields as indicated below (Figure 4-5).
- **Type:** One-Touch
 - **Line:** Line 1
 - **Parameter:** the phone number or extension
 - **Label Name:** the name that will appear on the phone screen

| Flexible Button Settings | | | | |
|--------------------------|-------------|---------|----------------------|----------------------|
| Flexible Button Settings | | | | |
| No | Type | Line | Parameter | Label Name |
| 1 | One-Touch ▼ | Line1 ▼ | 4805551234 | John's Cell |
| 2 | ▼ | ▼ | <input type="text"/> | <input type="text"/> |
| 3 | ▼ | ▼ | <input type="text"/> | <input type="text"/> |
| 4 | ▼ | ▼ | <input type="text"/> | <input type="text"/> |
| 5 | ▼ | ▼ | <input type="text"/> | <input type="text"/> |
| 6 | ▼ | ▼ | <input type="text"/> | <input type="text"/> |
| 7 | ▼ | ▼ | <input type="text"/> | <input type="text"/> |

Figure 4-5: Set Speed Dials

From the NextOS 3.0 Portal

1. For Administrators, log in to the NextOS 3.0 Beta portal by visiting www.nextiva.com and clicking on the customer Login found at the top right.
2. Log in to the NextOS 3.0 Beta portal with your login credentials.
3. From the main dashboard, click **Manage** in the **Users** tile (Figure 4-6).

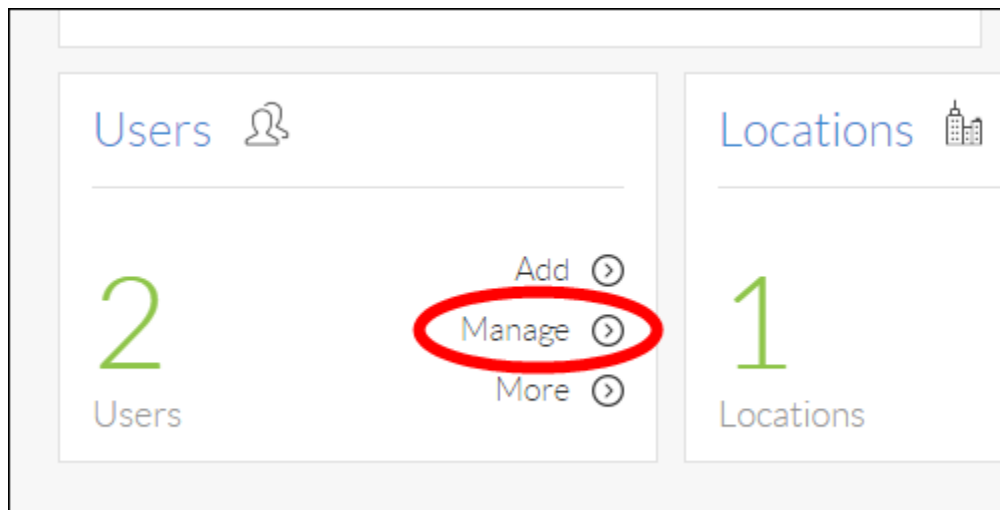

Figure 4-6: Manage Users

4. Hover your cursor over the user you want to set up speed dials for, and click the **pencil icon** to the right (Figure 4-7).

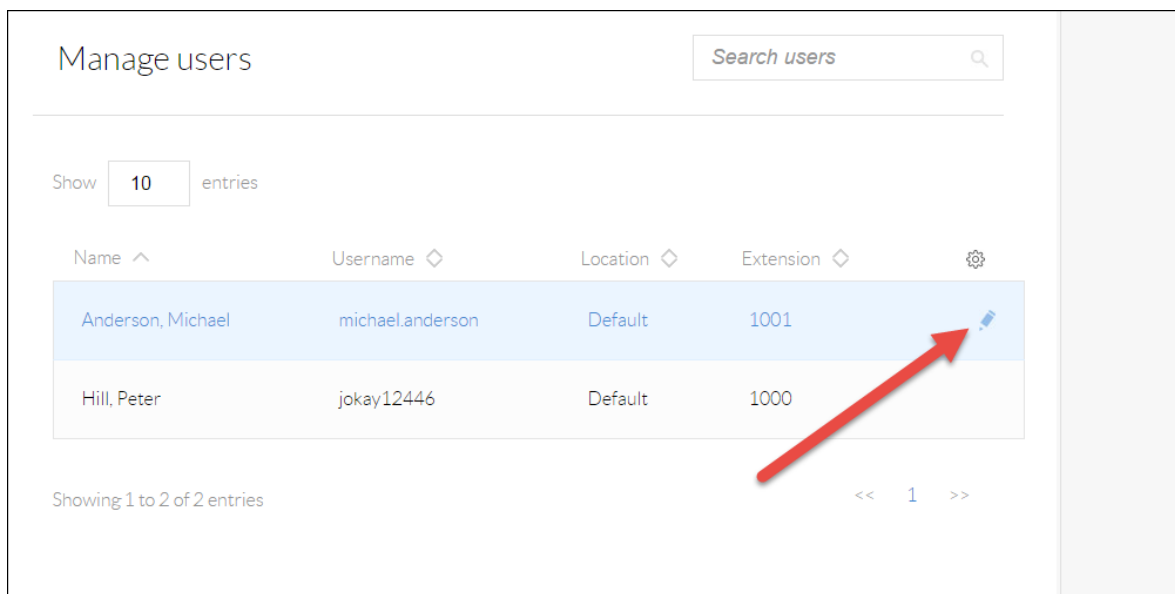

Figure 4-7: Edit User

5. Scroll down and select the **Routing** section (Figure 4-8).

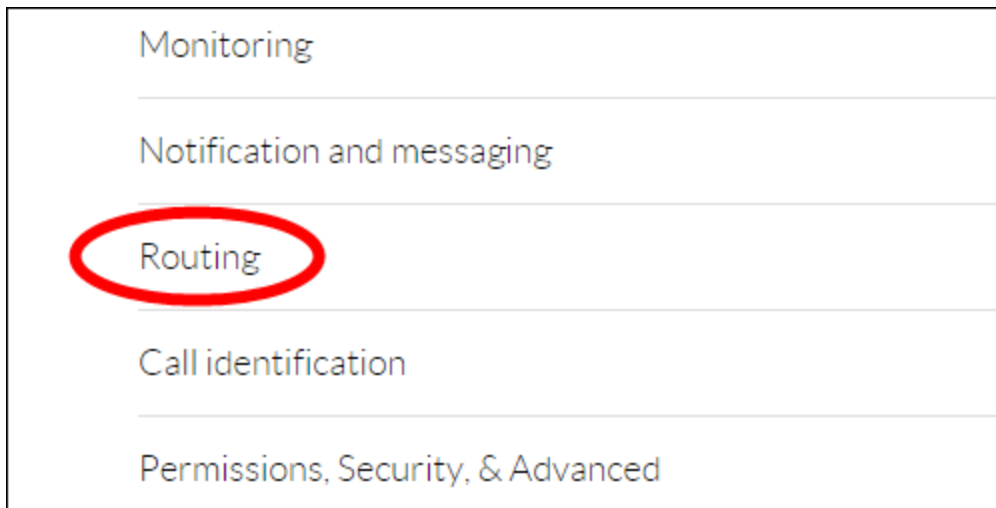

Figure 4-8: Routing Section

6. Click the **pencil icon** to the right of Speed dial (Figure 4-9).

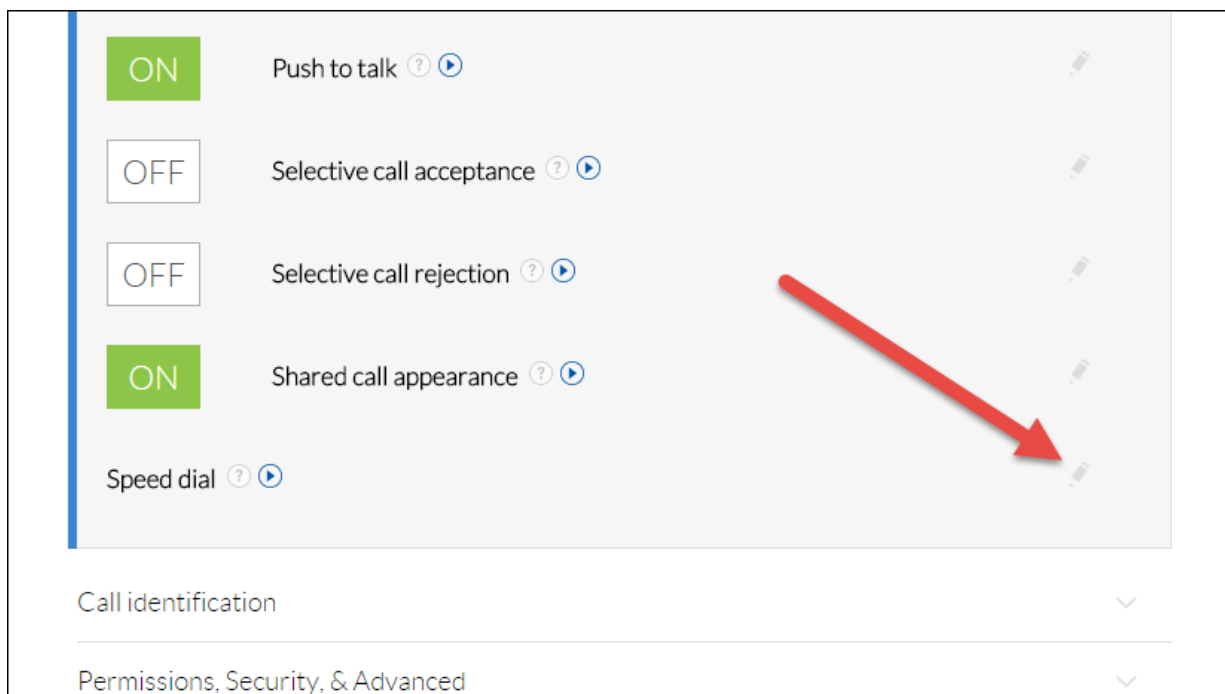

Figure 4-9: Speed Dial

7. Click the **plus sign** at the bottom-right (*Figure 4-10*).

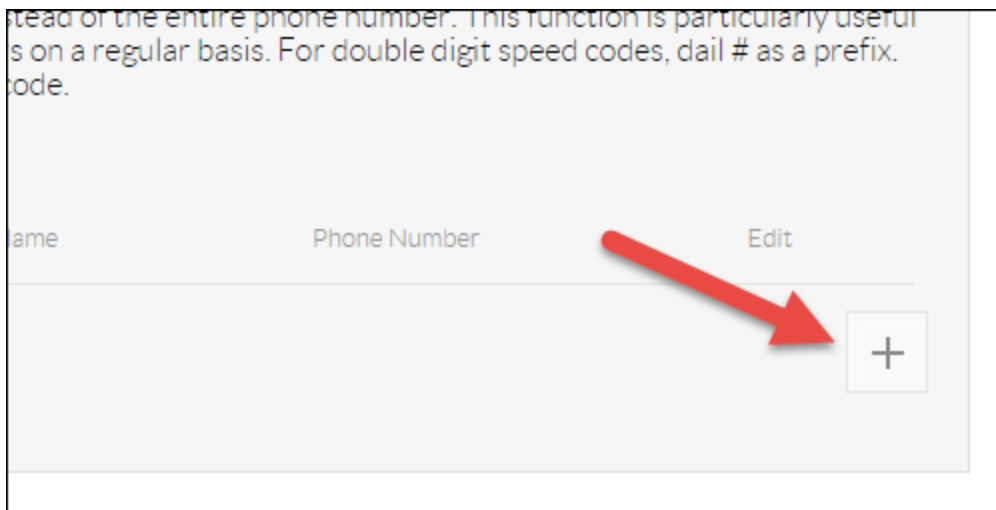

Figure 4-10: Add Speed Dial

8. Select the speed dial number from the **Option** drop-down list (*Figure 4-11*).

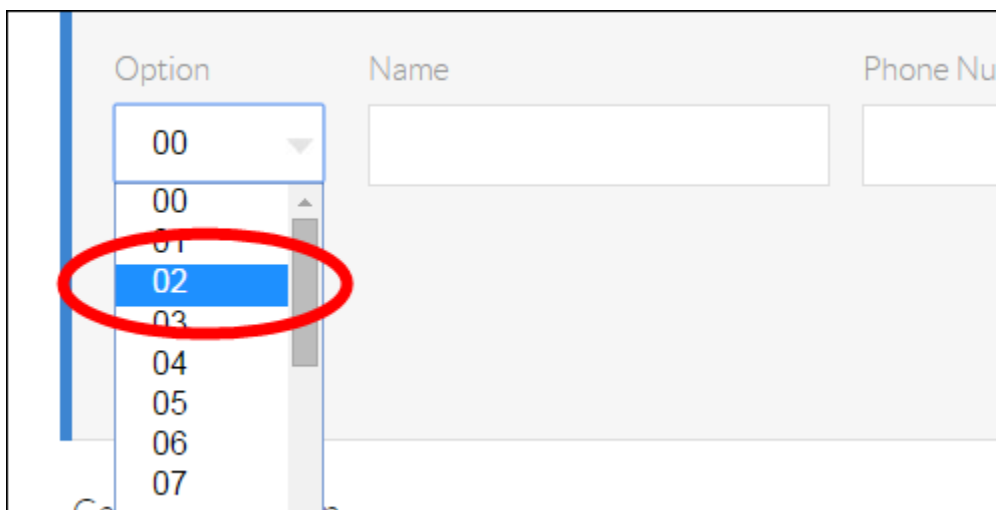
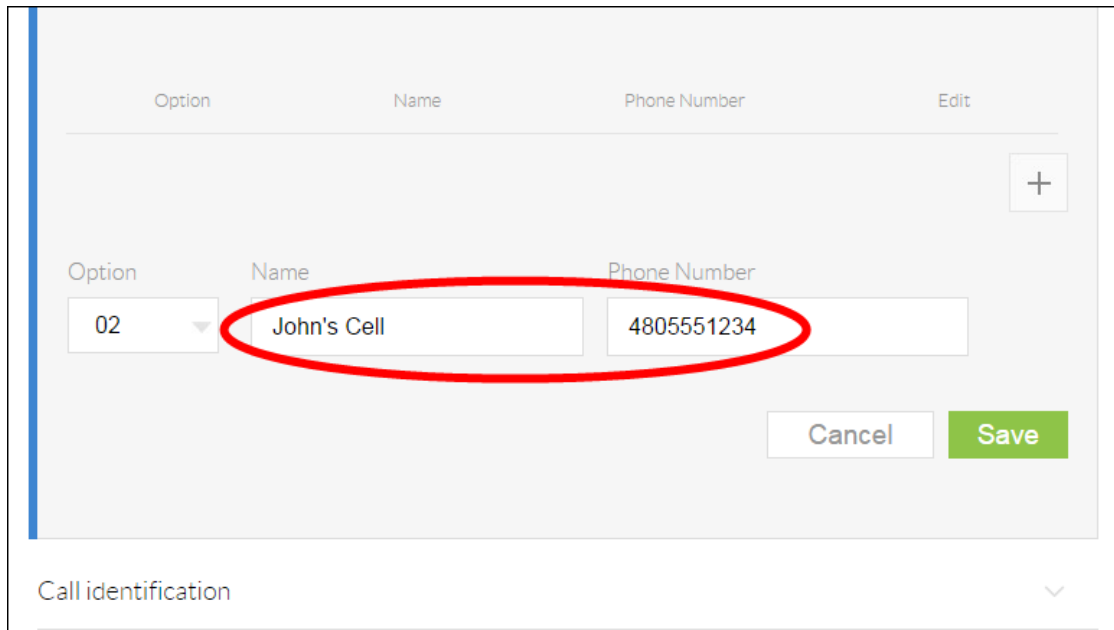

Figure 4-11: Select Speed Dial Number

9. Enter a descriptive name for the speed dial in the **Name** text box, and then enter the phone number or extension in the **Phone Number** text box. Please note that special characters or spaces are not supported for the speed dial descriptive name (*Figure 4-12*).



| Option | Name | Phone Number | Edit |
|--------|-------------|--------------|------|
| 02 | John's Cell | 4805551234 | |

Call identification

Figure 4-12: Configure Speed Dial

10. Click the green **Save** button at the bottom-right of the Speed dial menu. A pop-up message appears stating that the speed dial 100 settings have been saved successfully (*Figure 4-13*).

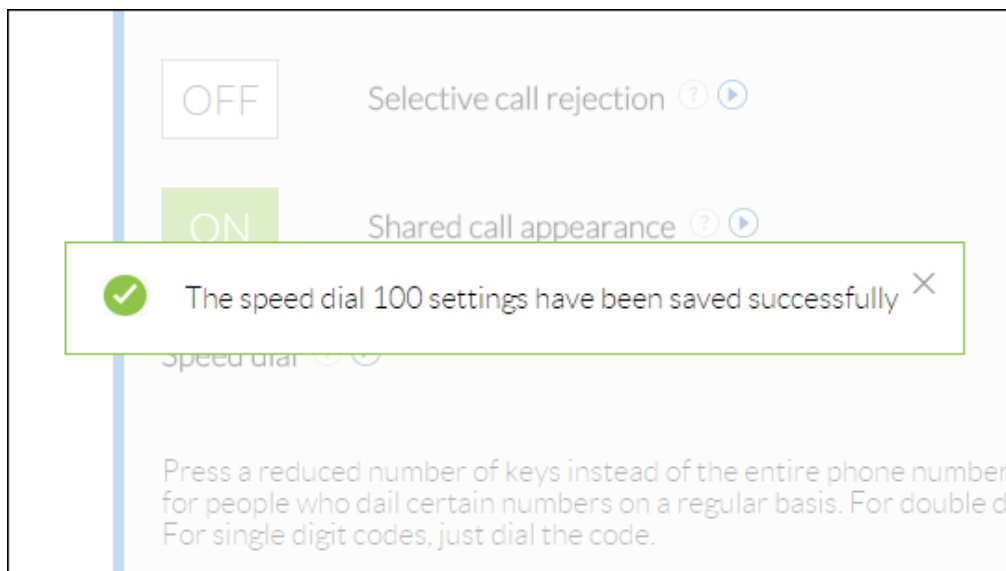

Figure 4-13: Confirmation Message

To use speed dials, go **off-hook** with your phone. Enter #, followed by the speed dial number (ex. #02) to connect to the assigned phone number. If the speed dial number is lower than 10, you must enter the 0 preceding the number to create a two-digit number. If you are using a softphone, dial #, followed by the speed dial number, and then press the dial button.

Automatic Call Distribution (ACD)

The Panasonic KX-UTG 300B supports phone integration with Nextiva Call Center Pro and Nextiva Call Center Enterprise's ACD states, allowing agents to go available and sign out of a call center from their phone's interface. To set up this feature, contact Nextiva Support.

Basic Phone Usage

Making a Call

NOTE: In this guide **off-hook** is used to describe when a phone is in use, or has a dial tone before a call is made. **On-hook** describes when a phone is idle.

1. Go **off-hook**, or press the **SP-PHONE** or **HEADSET** button.

NOTE: You can also initiate a call by pressing the **New Call** softkey at the bottom of the screen while the phone is idle (not in use). After doing so, you hear a dial tone through the speakerphone (*Figure 5-1*).

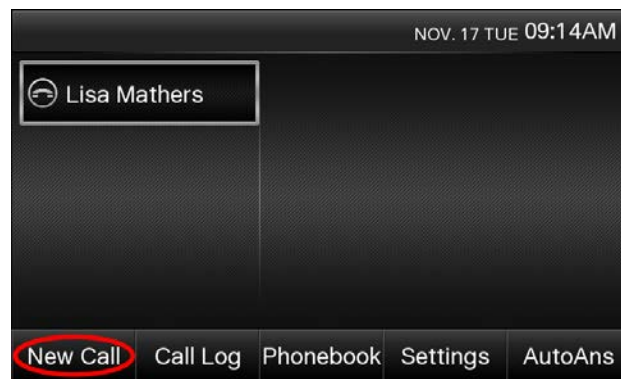

Figure 5-1: New Call

2. Dial the phone number or extension of the party you want to call, and then press the **Send** softkey at the bottom of the screen (*Figure 5-2*).

NOTE: If you dial the full 10-digit number of the party you want to call, the Panasonic KX-UTG 300B will automatically start dialing so pressing the Send softkey is not necessary.

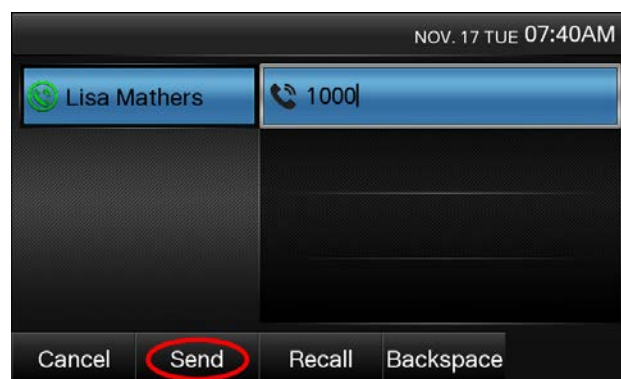

Figure 5-2: Send Softkey

- When finished, go **on-hook**, or press the **SP-PHONE** or **HEADSET** button to disconnect the call.

NOTE: You can also disconnect the call by pressing the **End Call** softkey at the bottom of the screen (*Figure 5-3*).



Figure 5-3: End Call Softkey

Making a Second Call

- While on a call, press the **HOLD** button to put the party you are speaking to on hold.
- Press the **New Call** softkey at the bottom of the screen. (*Figure 5-4*)



Figure 5-4: New Call

- Dial the phone number or extension of the party you want to call, and then press the **Send** softkey at the bottom of the screen. After you are connected to the second party, both calls will appear on the screen, with the active call highlighted in blue (*Figure 5-5*).

NOTE: If you dial the full 10-digit number of the party you want to call, the Panasonic KX-UTG 300B will automatically start dialing so pressing the Send softkey is not necessary.



Figure 5-5: Second Phone Call

- To go back to the first party, press the corresponding entry on the screen. The second party is automatically put on hold and you will be speaking to the first party again (*Figure 5-6*).

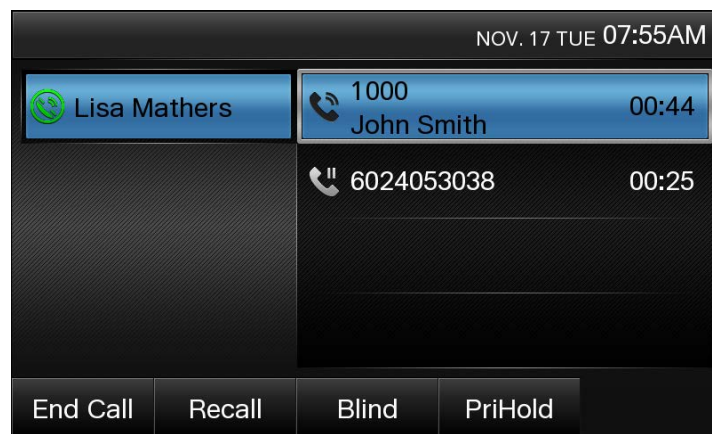

Figure 5-6: Selecting Active Calls

5. To end the call with either party, press the **End Call** softkey at the bottom of the screen while on that active call (Figure 5-7).

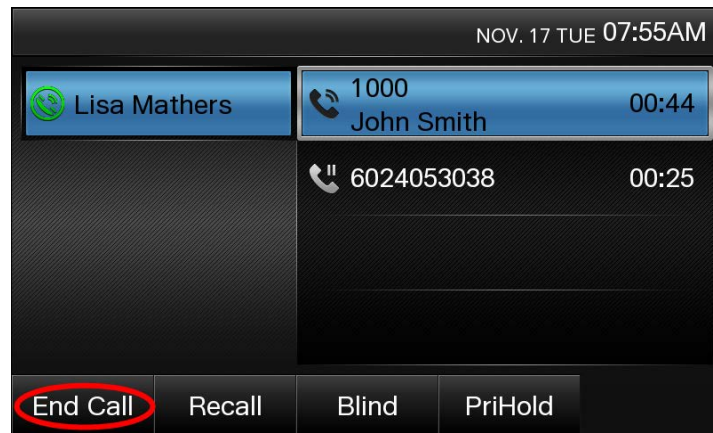

Figure 5-7: End Call

NOTE: Disconnecting with one party does not automatically take the other party off hold. To speak to the other party, press the **Resume** softkey at the bottom of the screen (Figure 5-8).

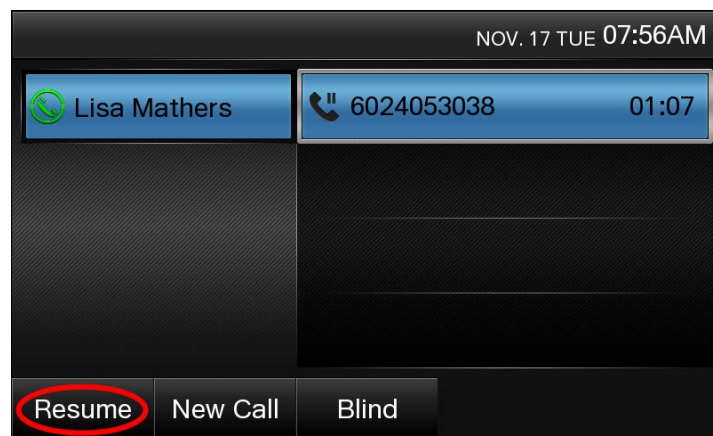

Figure 5-8: Resume Call

Accepting a Call

1. While the phone is ringing, go **off-hook**, or press the **SP-PHONE** or **HEADSET** button.

NOTE: You can also press the **Answer** softkey at the bottom of the screen to answer a call. Doing so automatically answers using the speakerphone (*Figure 5-9*).



Figure 5-9: Answer Call

To change this default behavior so the phone automatically answers using the headset, press the **HEADSET** button while the phone is ringing. A headset icon appears in the upper-left corner of the screen. Pressing the Answer softkey in the future automatically answers using the headset (*Figure 5-10*).



Figure 5-10: Headset Mode

NOTE: Pressing the **SP-PHONE** button to switch to speakerphone takes you out of headset mode and puts you into speakerphone mode. After this, pressing the Answer softkey automatically answers using the speakerphone.

Accepting a Second Call

1. When you hear the call waiting tone through the handset, speakerphone, or headset, press the **Answer** softkey at the bottom of the screen. The first party is put on hold, and you are speaking to the second party (*Figure 5-11*).



Figure 5-11: Answering a second Call

2. To go back to the first party, press the corresponding entry on the screen. The second party is automatically put on hold and you will be speaking to the first party again (*Figure 5-12*).

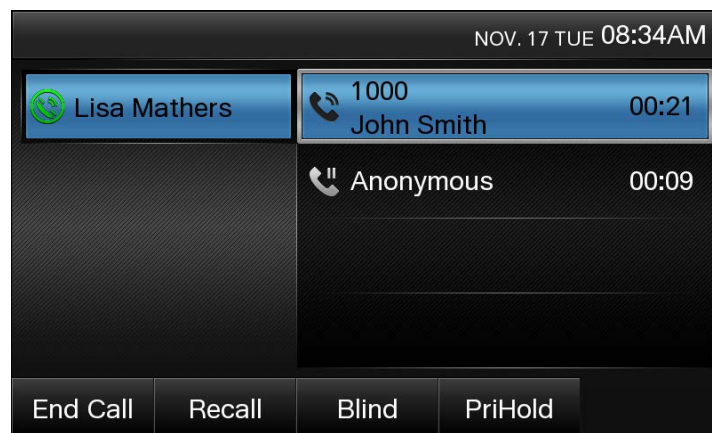

Figure 5-12: Selecting Active Calls

- To end the call with either party, press the **End Call** softkey at the bottom of the screen while on that active call (Figure 5-13).

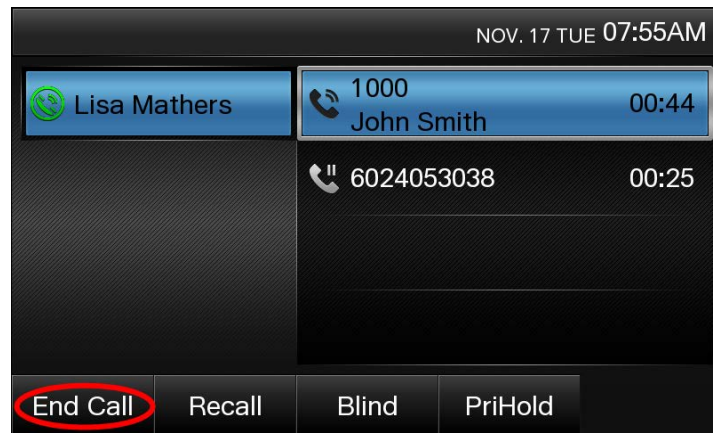

Figure 5-13: End Call

NOTE: Disconnecting with one party does not automatically take the other party off hold. To speak to the other party, press the **Resume** softkey at the bottom of the screen (Figure 5-14).

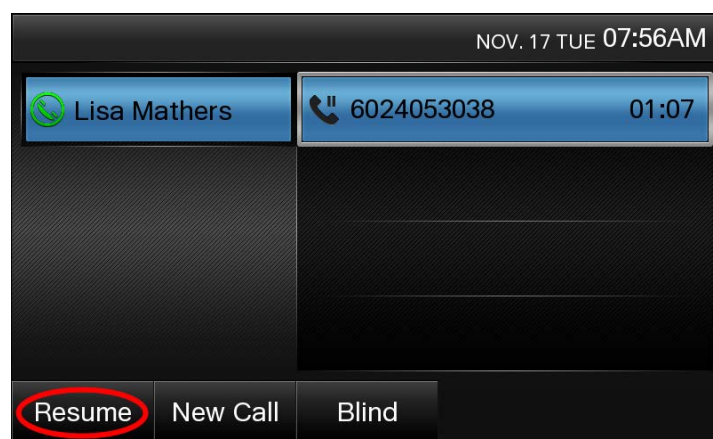

Figure 5-14: Resume Call

Terminating a Call

You can disconnect a call at any time by pressing the **End Call** softkey at the bottom of the screen. Alternatively, if using the handset, speakerphone or a headset, you can disconnect the call by going **on-hook** or pressing the **SP-PHONE** or **HEADSET** button, respectively.

Transferring a Call

There are two types of transfers – a warm transfer (attended) and a blind transfer (unattended). A warm transfer occurs when you speak to the party you are transferring the call to before you transfer the call to them. With a blind transfer you do not speak to the receiving party before transferring the call to them.

Warm Transferring

1. While on a call, press the **TRANSFER** button on the bottom-right of the phone. The party you were speaking with is put on hold, and you will hear a dial tone.
2. Dial the phone number or extension of the party you want to transfer the call to, and then press the **Send** softkey at the bottom of the screen. Wait for the other party to answer so you can speak to them before transferring the call.

NOTE: If you dial the full 10-digit number of the party you want to call, the Panasonic KX-UTG 300B will automatically start dialing so pressing the Send softkey is not necessary. To cancel the transfer and return to the first party, press the **Cancel** softkey at the bottom of the screen, and then press the **Resume** softkey to resume the call with the first party (*Figure 5-15*).



Figure 5-15: Cancel Transfer

3. When the other party is ready to accept the call, press the **TRANSFER** button again. The first party, which was on hold, is transferred to the second party.

Blind Transferring

1. While on a call, press the **Blind** softkey at the bottom of the screen (*Figure 5-16*).



Figure 5-16: Blind Transfer

2. Dial the phone number or extension of the party you want to transfer the call to, and then press the **Send** softkey at the bottom of the screen.

NOTE: If you dial the full 10-digit number of the party you want to call, the Panasonic KX-UTG 300B will automatically start dialing so pressing the Send softkey is not necessary.

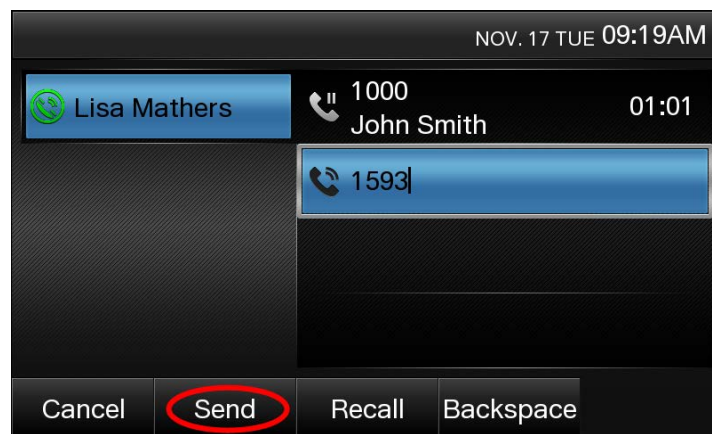

Figure 5-17: Send Transfer

NOTE: To cancel the transfer and return to the first party, press the **Cancel** softkey at the bottom of the screen, and then press the **Resume** softkey to resume the call with the first party (Figure 5-18).



Figure 5-18: Cancel Blind Transfer

Conferencing

1. While on a call, press the **CONFERENCE** button on the bottom of the phone.
2. Dial the phone number or extension of the party you want to add to the conversation, and then press the **Send** softkey. Wait for the other party to answer so you can speak to them before conferencing in the original party. You cannot conference in the first party until the second party answers.

NOTE: If you dial the full 10-digit number of the party you want to call, the Panasonic KX-UTG 300B will automatically start dialing so pressing the Send softkey is not necessary (Figure 5-19).

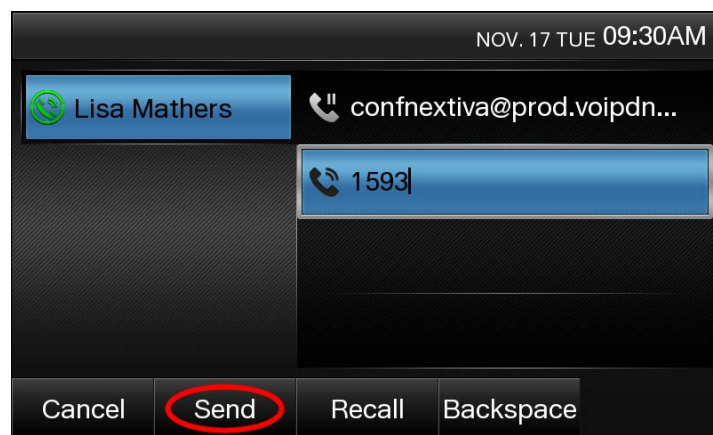

Figure 5-19: Conferencing

NOTE: To cancel the conference and return to the first party, press the **Cancel** softkey at the bottom of the screen. Next, press the **Resume** softkey to resume the call with the first party (Figure 5-20).



Figure 5-20: Cancel Conference

3. After the second party answers and you are ready to begin the conference call, press the **CONFERENCE** button again to add the original party to the conversation. You are then speaking with both parties at once.
4. To add a third party to the conference, repeat steps 1 through 3 above.

Checking Voicemail

When you have a new voicemail message, the Panasonic KX-UTG 300B phone displays an **envelope** on the screen and the message waiting indicator light on the upper-right of the phone turns **solid red**. You will also hear a stutter when you go off-hook or press the SP-PHONE or HEADSET button.

NOTE: The phone does not display the number of voicemail messages you have. The number that appears to the right of the envelope is the number of missed calls, which may or may not be the same as the number of voicemail messages you have.

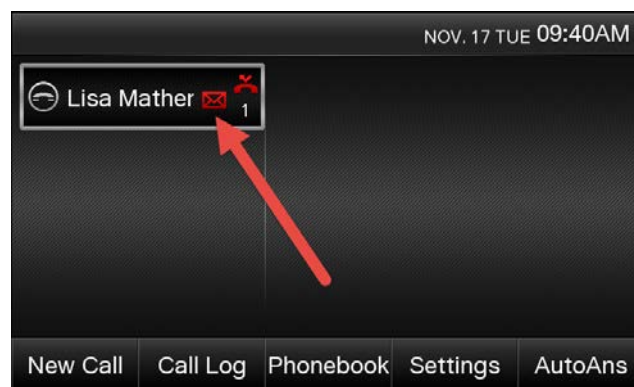

Figure 5-21: Voicemail Indicator

1. Press the **MESSAGE** button on the left side of the phone. It does not matter whether you go off-hook before or after pressing the MESSAGE button.
2. Enter your password when prompted. The default password is **0000#**.
3. If this is your first time checking your voicemail, follow the prompts to change your password and record your name.
4. Press **1** to access your voice mailbox.
5. Press **1** to listen to your messages.
6. When finished listening to your voicemails, press the **End Call** softkey at the bottom of the screen to terminate the call or proceed to the instructions below.

By default, if you do not answer your phone after 3 rings the call is forwarded to voicemail, and callers hear your recorded name followed by a message saying “is not available to take your call. Please leave a message after the beep.” If desired, you can set up a longer, more personal greeting after the initial voicemail setup is complete.

Recording a Custom No Answer Greeting

To set up a custom No Answer greeting, which is the default greeting that plays if you do not answer your phone after 3 rings, follow the instructions below.

1. Press the **MESSAGE** button on the left side of the phone. It does not matter whether you go off-hook before or after pressing the MESSAGE button.
2. Enter your password when prompted.
3. Press **1** to access your voice mailbox.
4. Press **3** to record a No Answer greeting.
5. Press **1** to record a new No Answer greeting, and press **#** when you are done speaking.

You will hear additional menu options after you press **#** to listen and rerecord the new greeting if necessary. Once you are satisfied with your new greeting, the greeting will be updated and implemented for your voicemail.

Directories

Remote directories are not supported on the Panasonic KX-UTG 300B.

Call Lists

NOTE: Call lists will survive a reboot, but not a factory reset.

1. Press the **Call Log** softkey at the bottom of the screen.



Figure 5-22: Call Log

2. Select the type of calls you want to see. Alternatively, you can select **All Calls** to see a list of all calls. In the example below, **Received Calls** is selected to see a list of the calls that have been received (Figure 5-23).

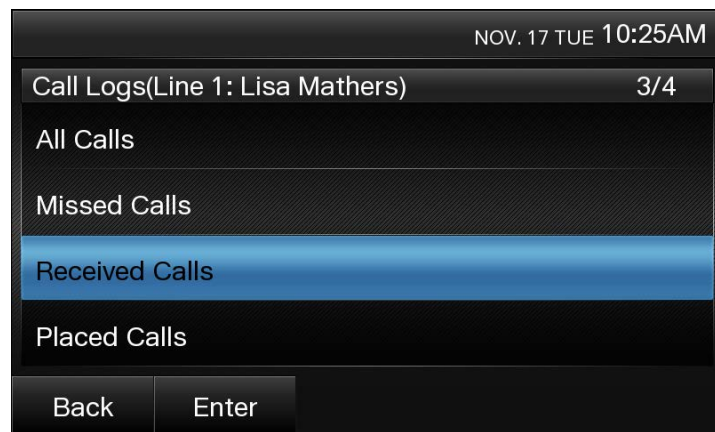

Figure 5-23: Call Log Options

- To make a call out to an entry in the list, press the **Call** softkey at the bottom of the screen.



Figure 5-24: Call from List

- To clear the list of calls, press the **More** softkey at the bottom of the screen, and then press the **Clear List** softkey at the bottom of the screen.

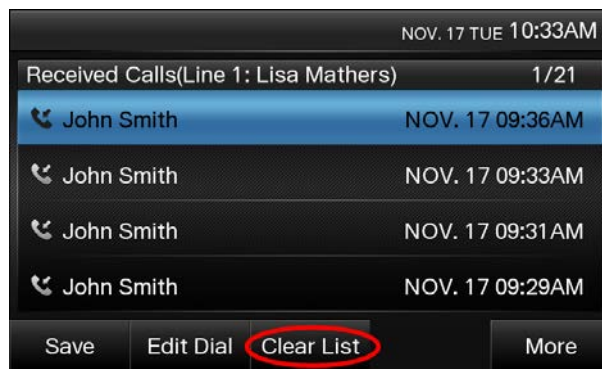

Figure 5-25: Clear List

- After pressing the Clear list softkey, confirm you want to clear the list of calls by pressing **Yes** at the bottom of the screen (Figure 5-26).

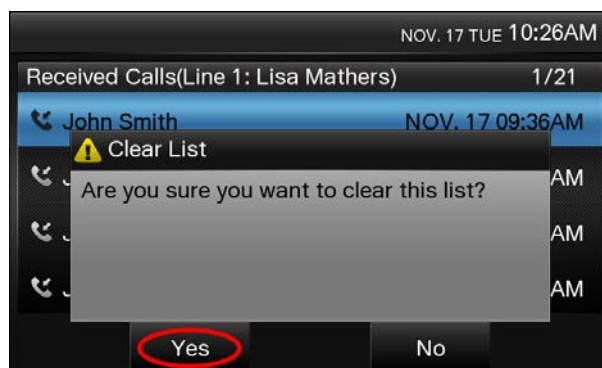

Figure 5-26: Clear List

Missed Calls

When there is a missed call, a red missed call icon appears next to the user's name in the upper-left corner of the display screen, with the number of missed calls below that (*Figure 5-27*).

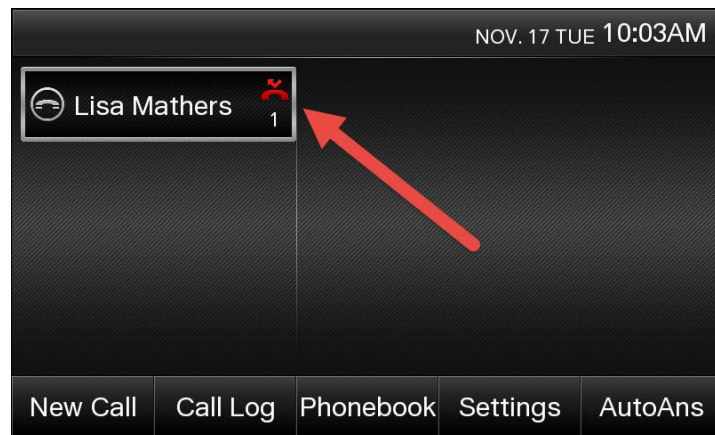

Figure 5-27: Missed Call Icon

Transferring to a Party on your Call List

1. While on a call, press the **TRANSFER** button on the bottom-right of the phone. The party you were speaking to is put on hold, and you hear a dial tone.
2. Press the **Call Log** softkey at the bottom of the screen (*Figure 5-28*).



Figure 5-28: Access the Call Logs

3. Select the type of calls you want to see. Alternatively, you can select **All Calls** to see a list of all calls. In the example below, **Missed Calls** is selected to see a list of the calls that have been missed (*Figure 5-29*).

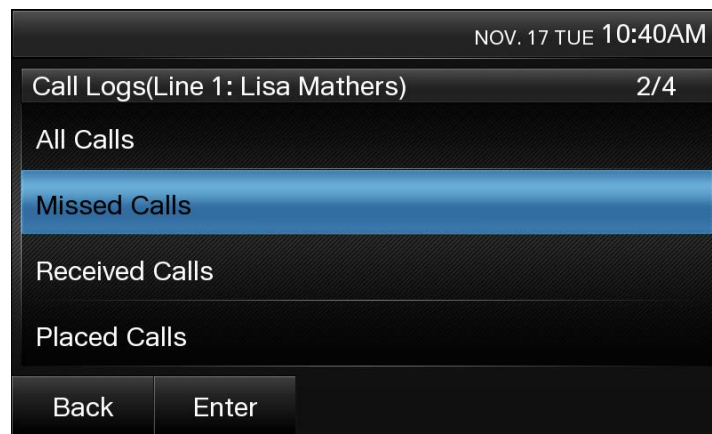

Figure 5-29: Select the Specific List

4. To make a call out to an entry in the list you want to transfer the call to, press the **Call** softkey at the bottom of the screen (*Figure 5-30*).

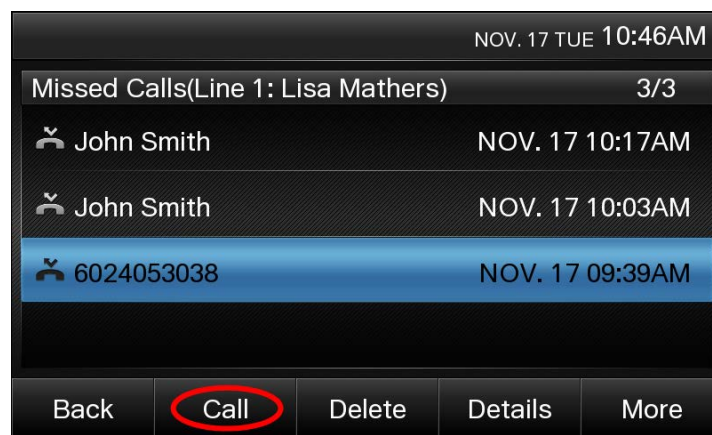

Figure 5-30: Call the Entry

5. When the other party is ready to accept the call, press the **TRANSFER** button again. The first party, which was on hold, is transferred to the second party.

Conferencing in a Party on your Call List

1. While on a call, press the **CONFERENCE** button on the bottom-right of the phone.
2. Press the **Call Log** softkey at the bottom of the screen (*Figure 5-31*).



Figure 5-31: Access the Call Log

3. Select the type of calls you want to see. Alternatively, you can select **All Calls** to see a list of all calls. In the example below, **Missed Calls** is selected to see a list of the calls that have been missed.

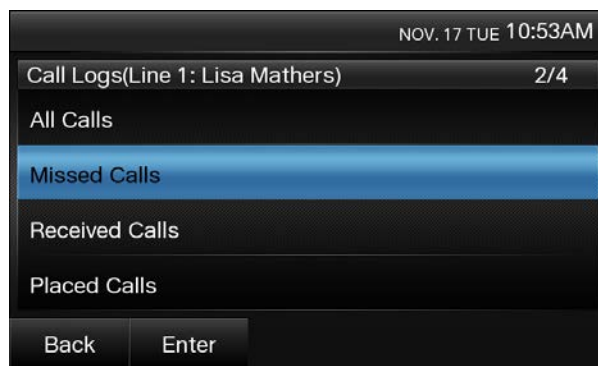

Figure 5-32: Select the Specific List

- To call an entry in the list, press the **Call** softkey at the bottom of the screen (*Figure 5-33*).

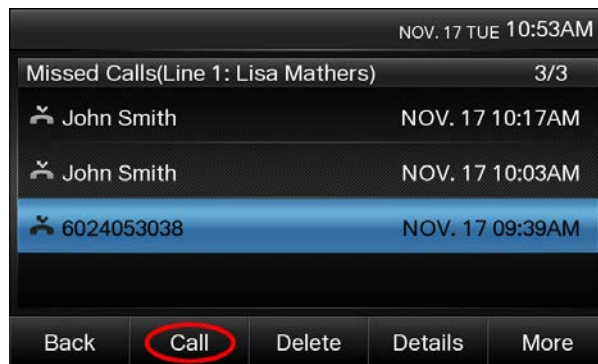

Figure 5-33: Call the Entry

- After the second party answers and you are ready to begin the conference call, press the **CONFERENCE** button again to add the original party to the conversation. You are then speaking with both parties at once.
- To add a third party to the conference, repeat steps 1 through 5 above.

Using Speed Dials

- Go **off-hook** or press the **Speaker** or **Headset** button.
- Enter **#**, then the speed dial number, then press the **Dial** softkey at the bottom of the screen. After a few seconds, the call initiates.

Using the Flexible Buttons

- Press the **FlexibleBtn** softkey at the bottom of the screen (*Figure 5-34*).

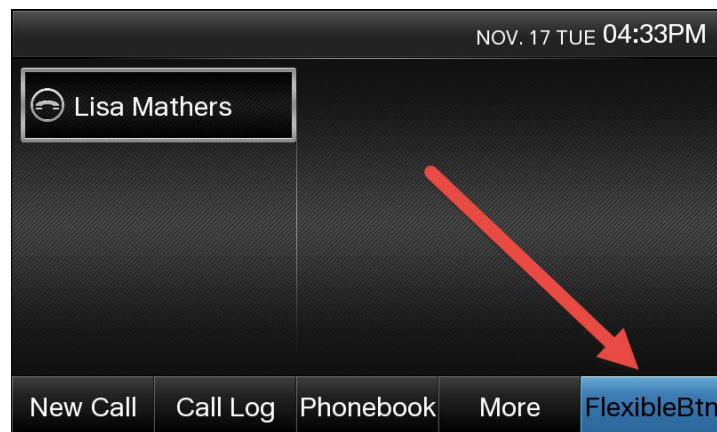

Figure 5-34: FlexibleBtn

2. Press the **name** of the speed dial contact on the screen. A call is initiated to that contact (*Figure 5-35*).

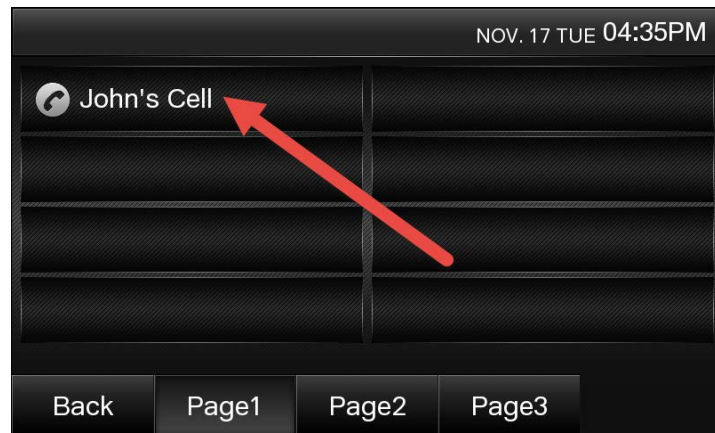

Figure 5-35: Select Speed Dial Entry

Changing ACD States

In order for a call center agent to change their ACD state from a Panasonic KX-UTG 300B phone, ACD functionality needs to be enabled on the phone using custom tags. See the section above titled Automatic Call Distribution (ACD).

Signing In

To sign in to a queue, press the **More** softkey, followed by the **ASignIn** softkey. The screen updates to show a check mark next to your name (*Figure 6-1*).



Figure 6-1: Signed in Agent

NOTE: Signing in will not route calls that are in queue to your phone. To receive calls, you need to change your ACD state to **Available**. To do this, press the **More** softkey, followed by the

Available softkey. The screen updates to show a green check mark next to your name. Any calls that are in queue could potentially route to your phone.



Figure 6-2: Available Agent

Going Unavailable

Changing your ACD state to Unavailable (going unavailable) is typically done when taking a break or when you are away from your phone. Follow the instructions below to do this:

1. Press the **More** softkey at the bottom of the screen once, then press the **Unavailable** softkey at the bottom of the screen.

NOTE: You will not be able to go unavailable if you are on an active call. You will need to wait until after the call has ended to go unavailable (*Figure 6-3*).

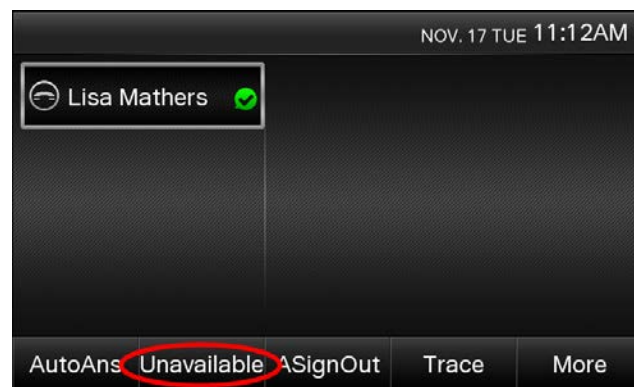

Figure 6-3: Unavailable Softkey

2. Enter the two-digit reason code for going unavailable, and then press the **OK** softkey at the bottom of the screen (*Figure 6-4*).

NOTE: Reason codes are provided to you by the administrator for your Nextiva account. If you have not been provided with any reason codes, leave the field blank and press the **OK** softkey without entering a value.

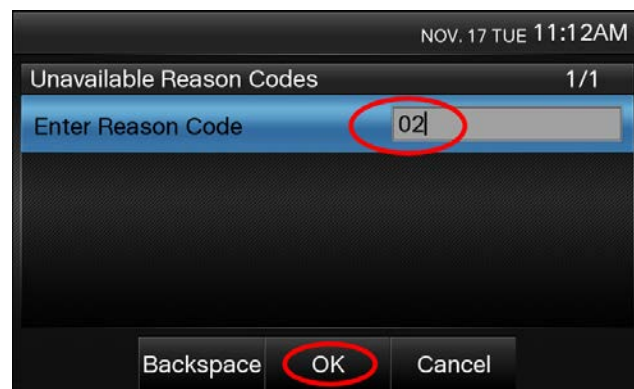

Figure 6-4: Reason Code

After going unavailable, the screen updates to show a **red clock** next to your name (*Figure 6-5*).



Figure 6-5: Unavailable Agent

Going Available

When returning to your desk from a break, meeting, etc., you need to change your ACD state to Available (go available) again. To do this, press the **More** softkey at the bottom of the screen once, and then press the **Available** softkey at the bottom of the screen to go available. The screen updates to show a green check mark next to your name (*Figure 6-6*).



Figure 6-6: Available Softkey

Accepting a Call

Accepting a call is no different than when ACD functionality is not enabled.

Disposition Codes

Disposition Codes are attributes applied to a call to identify marketing promotions or other topics pertaining to a call. If the administrator for your Nextiva account has enabled disposition codes on your call center, you can apply a disposition code to a call while the call is still in progress. Follow the instructions below to do this:

1. While on a call, press the **More** softkey, followed by the **DispCode** softkey (*Figure 6-7*).



Figure 6-7: Disposition Code Softkey

2. **Enter** the disposition code given to you by the administrator of your Nextiva account, and then press the OK softkey at the bottom of the screen (*Figure 6-8*).

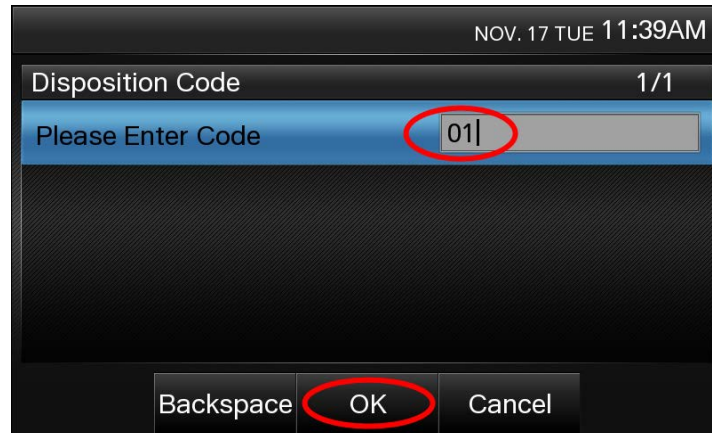

Figure 6-8: Disposition Code Entry

Wrap-Up

Wrap-Up refers to the time after a call ends but before another call is routed to your phone. This is an optional state that can be enabled or not enabled for your call center. If the administrator for your Nextiva account has enabled Wrap-Up on the call center, then immediately after the last active call ends on your Panasonic KX-UTG 300B phone, the icon to the right of your name changes to reflect the new Wrap-Up status.



Figure 6-9: Wrapping up Agent

From here, you can either wait for the default wrap-up time to expire (typically 30 seconds), or you can press the **More** softkey at the bottom of the screen once, and then press the **Available** softkey at the bottom of the screen to go available immediately.

Signing Out

When going to lunch, leaving for the day, etc., you need to sign out of your call center queues. To do this, press the **More** softkey at the bottom of the screen once, and then press the **ASOt** softkey at the bottom of the screen to sign out. (Figure 6-10).

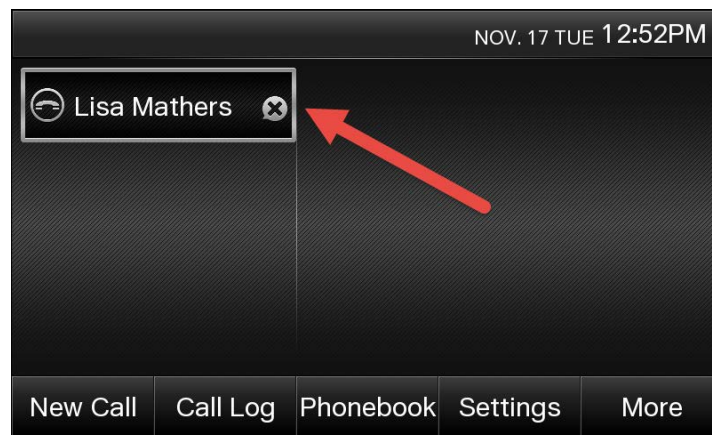

Figure 6-10: Signed Out Agent

Additional Features

Do Not Disturb (DND)

From the Phone

1. Press the **FORWARD/DO NOT DISTURB** button on the bottom-left of the phone. The Do Not Disturb option is automatically selected.
2. Press the **On** softkey at the bottom of the screen (Figure 7-1).

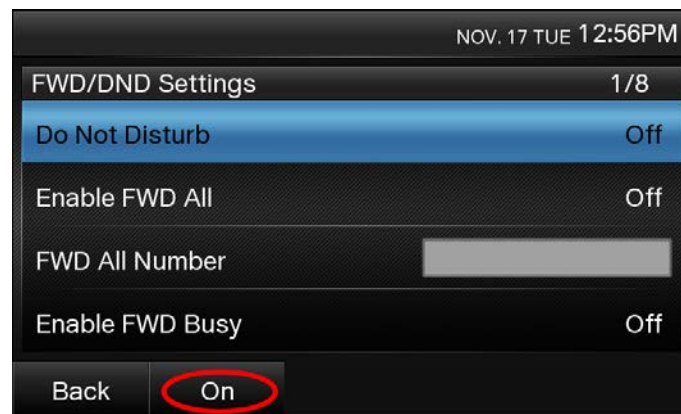

Figure 7-1: Turn on Do Not Disturb

3. Press the **Save** softkey at the bottom of the screen (Figure 7-2).

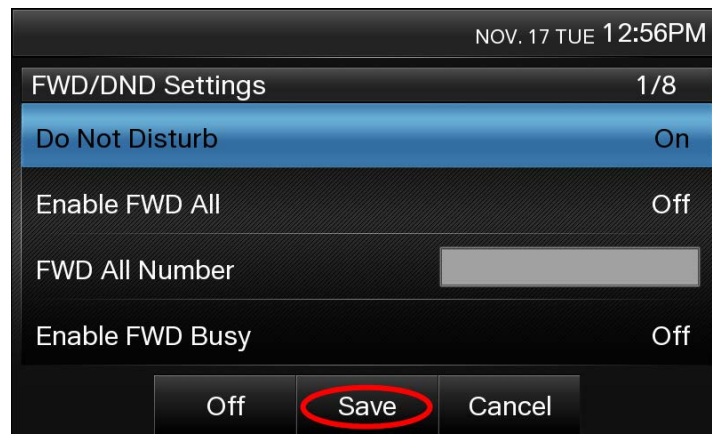

Figure 7-2: Save Changes

4. Press the **Back** softkey at the bottom of the screen. The icon to the left of your name updates to show DND is enabled.

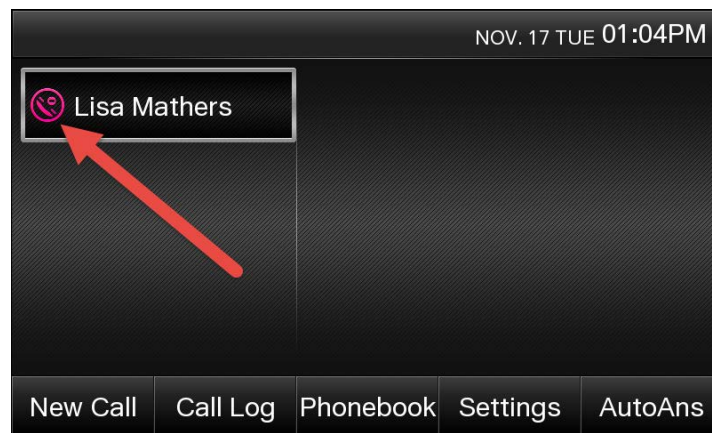

Figure 7-3: Agent on Do Not Disturb

5. To disable DND, repeat steps 1 through 4, selecting **Off** instead of On.

Using Star Codes

1. Go **off-hook** or press the **SP-PHONE** or **HEADSET** button.
2. Dial ***78**. You will hear an automated message saying your Do Not Disturb service has been activated successfully.
3. Press the **End Call** softkey at the bottom of the screen to disconnect the call. The phone icon next to your name updates to reflect that DND has been enabled.
4. To disable DND, repeat steps 1 through 3, dialing ***79** instead of ***78**.

Factory Reset

From the Phone's Menu

1. Press the **HOME** button on the bottom of the phone.
2. Select **Settings** from the menu (*Figure 8-1*).

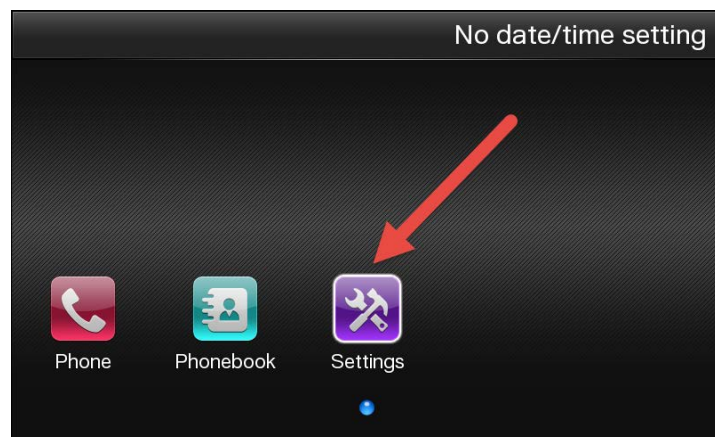

Figure 8-1: Settings

3. Scroll down and select **Change Level** from the menu to sign in as an administrator for the phone (*Figure 8-2*).

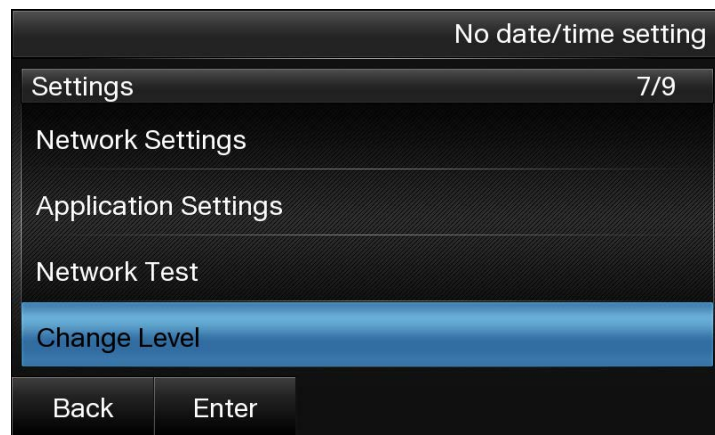

Figure 8-2: Change Level

4. Enter **admin** as the User ID and **adminpass** as the Password, and then press the Enter softkey at the bottom of the screen (Figure 8-3).

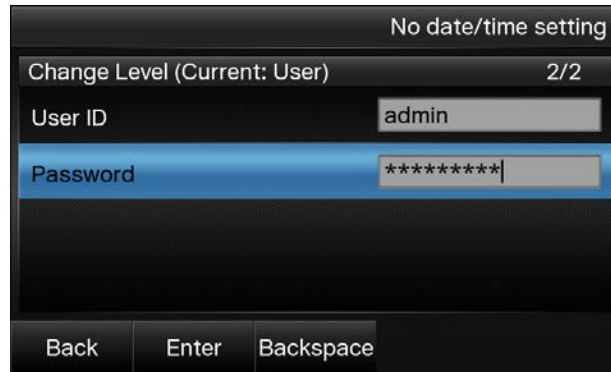

Figure 8-3: Admin Login

5. Scroll down and select **Reset** from the menu (Figure 8-4).

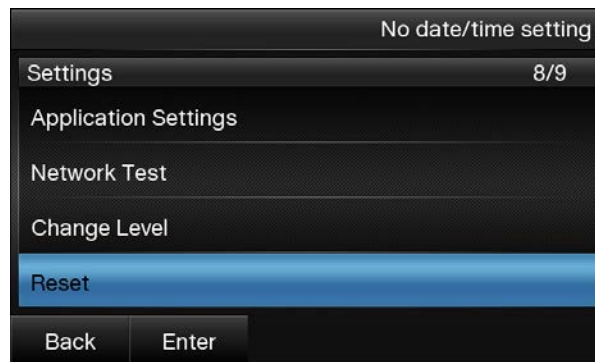

Figure 8-4: Reset Option

6. Select **Exclude Private Settings** from the menu (Figure 8-5).

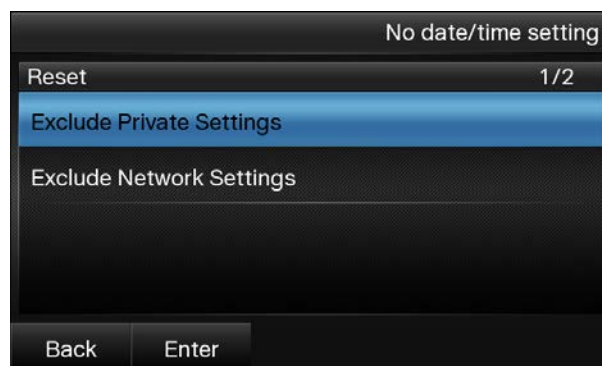

Figure 8-5: Exclude Private Settings

7. Confirm you want to factory reset the phone by selecting **Yes** at the bottom of the screen. After a few seconds the phone will automatically reboot (*Figure 8-6*).



Figure 8-6: Confirm Factory Reset

From the Web Configuration Utility

1. Enable the Web Configuration Utility and obtain the IP address of the phone. Select the **Menu** softkey, and then select **Settings** and press **#534** on the keypad to enable embedded web. Next, select the **Menu** softkey again, and then select **Settings** and locate **Information Display** to locate your phone's IP Address.
2. Enter the IP address of the phone into the address bar of a **web browser** (Internet Explorer, Firefox, Chrome, etc.) (*Figure 8-7*).

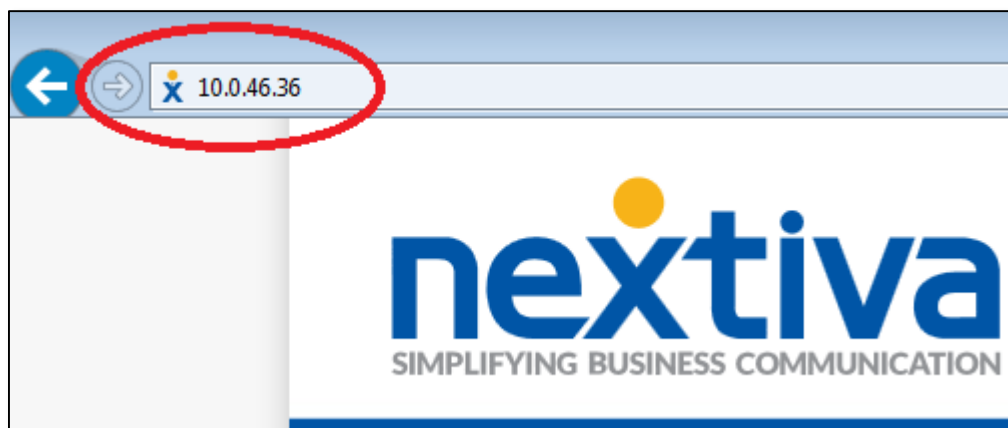

Figure 8-7: Navigate to the Phone's IP Address

3. Login with **admin** for the username and **adminpass** for the password (Figure 8-8).

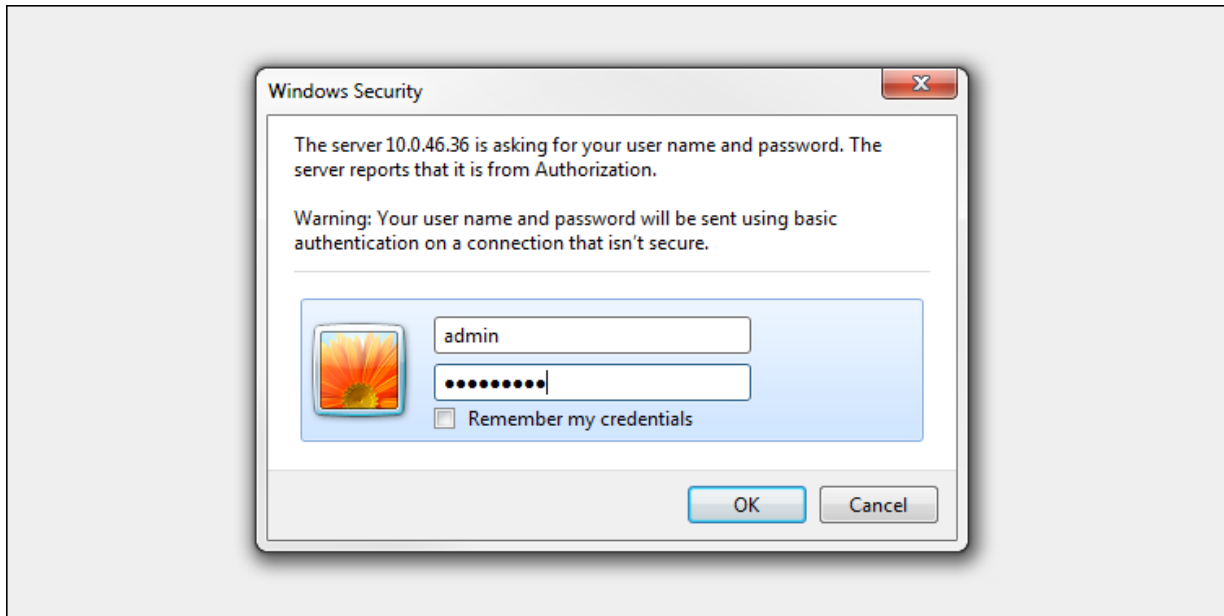

Figure 8-8: Log In to Phone Interface

4. Click the **Maintenance** tab at the top of the screen (Figure 8-9).

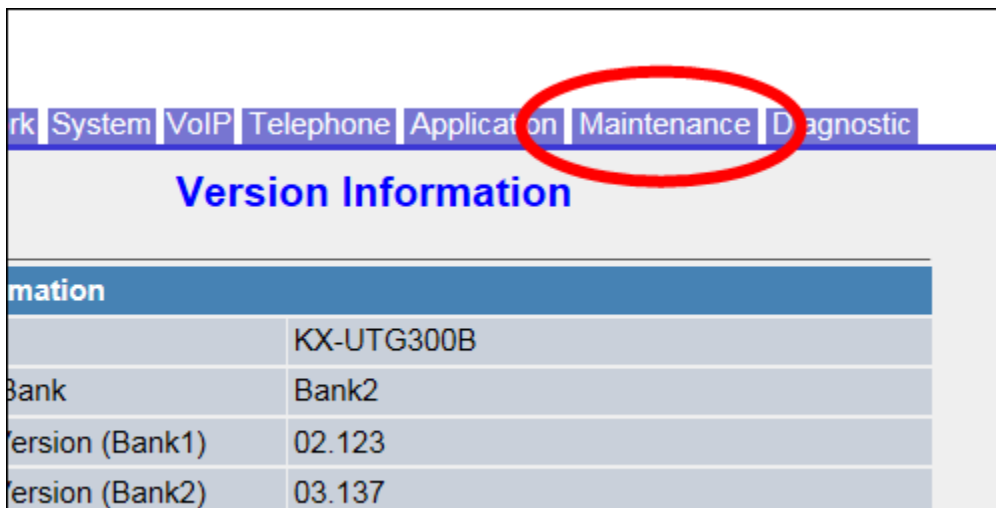

Figure 8-9: Maintenance Tab

5. Click **Reset & Restart** on the left side of the screen (*Figure 8-10*).

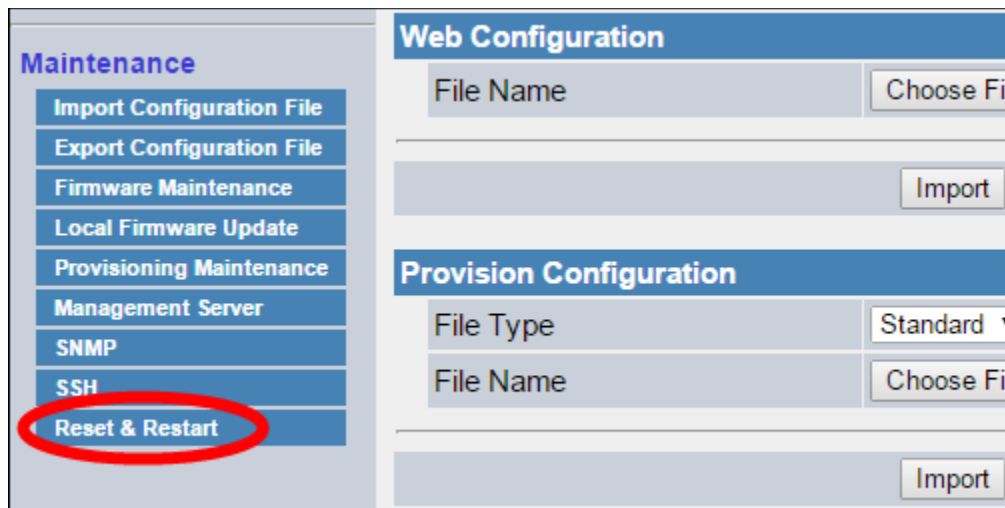

Figure 8-10: Reset and Restart

6. Click **Reset** under the **Factory Reset** heading (*Figure 8-11*).

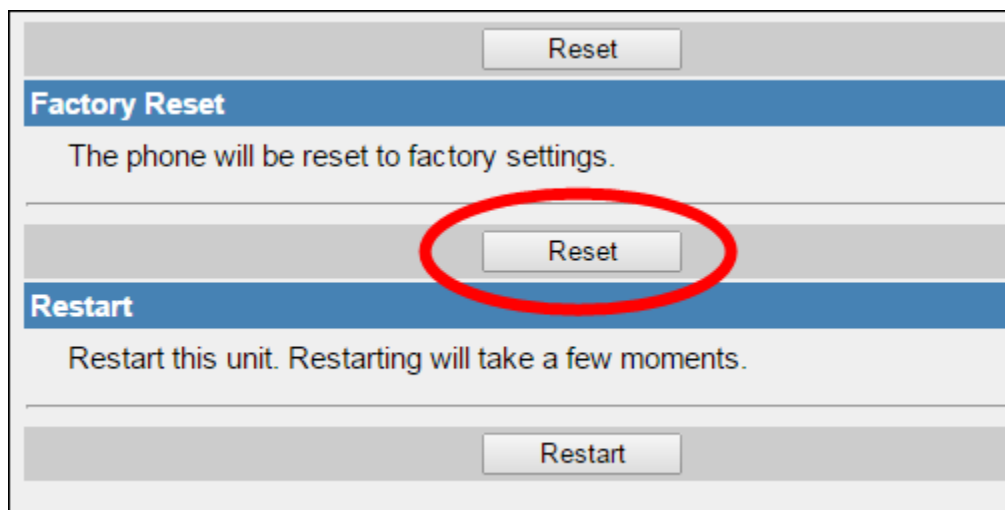

Figure 8-11: Factory Reset

7. Click **OK** when the pop-up message appears asking if you really want to reset the phone. After a few seconds the phone will automatically reboot.

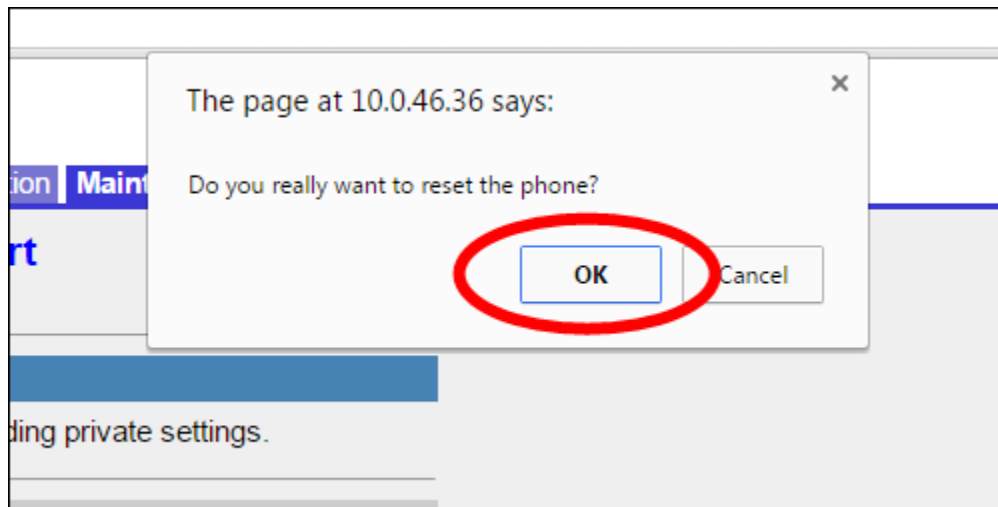

Figure 8-12: Confirm Factory Reset